

# NORTH AMERICAN STANDARD OUT-OF-SERVICE CRITERIA

**\*April 1, 2019**

## COMMERCIAL VEHICLE SAFETY ALLIANCE

---

<b>Part I – North American Standard Driver Out-of-Service Criteria</b>	<b>Pages 1 – 13</b>
<b>Part II – North American Standard Vehicle Out-of-Service Criteria</b>	<b>Pages 14 – 66</b>
<b>Part III – North American Standard Hazardous Materials/Dangerous Goods Out-of-Service Criteria</b>	<b>Pages 67 – 70</b>
<b>Part IV – North American Standard Administrative Out-of-Service Criteria</b>	<b>Pages 71 – 73</b>
<b>Appendix</b>	<b>Pages 74 – 93</b>

**THIS DOCUMENT REPLACES AND SUPERSEDES ALL PREVIOUS  
OUT-OF-SERVICE CRITERIA**



***Improving Uniformity in Commercial Motor Vehicle Safety and Enforcement***

**Commercial Vehicle Safety Alliance  
6303 Ivy Lane, Suite 310  
Greenbelt, MD 20770  
Phone: 301-830-6143 · [www.cvsa.org](http://www.cvsa.org)**

Missouri

**This page intentionally left blank.**

**PART I – DRIVER**

<u>DESCRIPTION</u>	<u>MANUAL PAGE</u>
<b>1. DRIVER’S AGE</b>	2
<b>2. OPERATOR’S/CHAUFFEUR’S LICENSE OR PERMIT (NON CDL)</b>	
Vehicle 26,000 lbs. or Less GVWR	2
Endorsements and Restrictions	2
<b>3. COMMERCIAL DRIVER’S LICENSE (CDL)</b>	
License	2
Commercial Learner’s Permit (CLP)	3
Endorsements and Restrictions	3
Classification	3
<b>*4. DRIVER MEDICAL/PHYSICAL REQUIREMENTS</b>	
*Skill Performance Evaluation Certificate	3
Medical Certificate	4
<b>5. SICKNESS</b>	5
<b>6. FATIGUE</b>	5
<b>7. DRUGS AND OTHER SUBSTANCES</b>	
Shall not be in Possession	5
Shall not be under the Influence	5
<b>8. INTOXICATING BEVERAGES</b>	
Under the Influence	5
Be On Duty or Operate	5
Out-of-Service Order Violation	6
<b>9. DRIVER'S RECORD OF DUTY STATUS – U.S.</b>	
Property-Carrying Vehicles	6
Passenger-Carrying Vehicles	7
Hours of Service Out-of-Service Order	7
Footnotes	8

**10. DRIVER'S RECORD OF DUTY STATUS – Canada**

Driver Impairment	10
13-Hour Rule	10
14-Hour Rule	10
16-Hour Rule	10
70/120-Hour Rules	10
10-Hour Off Duty Rule	10
24 Hours Off	10
No Daily Log	11
False Log	11
Footnotes	11

**11. DRIVER'S RECORD OF DUTY STATUS – Mexico**

Daytime Working Day	12
Daytime Working Week	12
Night Working Day	12
Night Working Week	12
Mixed Working Day	12
Mixed Working Week	12
No Record of Duty Status	13
No Previous 7 Days	13
False Record of Duty Status	13

**PART II – VEHICLE**

<b><u>DESCRIPTION</u></b>	<b><u>MANUAL PAGE</u></b>
<b>*1. BRAKE SYSTEMS</b>	
Defective Brakes ( <i>20 Percent Rule</i> )	16
Absence of Effective Braking Action	16
Audible Air Leak at Air Chamber	17
Missing Brakes	17
Brake Adjustment Limits	17
Brake Adjustment Limit Charts	18
Drum Air Brakes	20
Air Disc Brakes	21
Hydraulic and Electric Brakes	21
Front Steering Axle(s) Brakes ( <i>In Addition to the 20 Percent Rule</i> )	22
Inoperative or Missing Brake	22
Drum Air Brakes	22
Air Disc Brakes	23
Hydraulic Brakes	24
Spring Brake Chambers	24
Trailer Breakaway and Emergency Braking	24
Parking Brake	24
Brake Smoke/Fire	25
*Brake Drums or Rotors (Discs)	25
Air Brake Hose/Tubing	25
Air Pressure Gauge	26
Low Air Pressure Warning Device	26
Air Loss Rate	26
Tractor Protection System	27
Air Reservoir (Tank)	27
Air Compressor	27
Hydraulic Brakes	27
Vacuum Brakes	28
Performance-Based Brake Test (PBBT)	28
<b>*2. CARGO SECUREMENT</b>	
*General Securement	29
*Articles Not Restrained from Rolling	29
*Articles Beside Each Other and Secured by Transverse Tiedowns	29
*Aggregate Working Load Limit	29
*Tiedowns for Length – No Front End Structure	29
*Tiedowns for Length – Front End Structure	30
Commodity Specific Requirements	30
*Tiedown Defect Table	32
Chain Defects	32
Wire Rope Defects	33
Cordage (Fiber Rope) Defects	34

<u>DESCRIPTION</u>	<u>MANUAL PAGE</u>
Synthetic Webbing Defects	34
*Doleco USA Textile Link Tiedown Assembly	36
Steel Strapping Defects	38
Fitting/Attachment/Tensioning Device Defects	38
Anchor Point Defects	38
<b>3. COUPLING DEVICES</b>	
Fifth Wheels	39
Lower Coupler Assembly	39
Upper Coupler Assembly (Including Kingpin)	41
Pintle Hooks	43
Drawbar Eye	43
Drawbar/Tongue	44
Safety Devices	44
Hitch Systems (Excluding Fifth Wheels and Pintle Hooks)	45
Saddle-Mounts (Method of Attachment)	45
Full Trailer (Double Ring, Ball-Bearing Turntable)	45
<b>*4. DRIVELINE/DRIVESHAFT</b>	
Yoke Ends (Including Slip Yoke, Yoke Shaft, Tube Yoke and End Fitting Yoke)	46
*Universal Joint	46
Center Bearing (Carrier Bearing)	47
Driveshaft Tube	47
<b>*5. DRIVER'S SEAT (MISSING)</b>	
*Temporary Seating	48
<b>*6. EXHAUST SYSTEMS</b>	
*Leaks – All Commercial Motor Vehicles	48
*Gasoline-Powered Buses	48
*Buses Powered by Other Than Gasoline	48
*Location of Exhaust	48
<b>*7. FRAMES</b>	
*Frame Members	48
Tire and Wheel Clearance	49
<b>*8. FUEL SYSTEMS</b>	
Liquid Fuels	49
Gaseous Fuels	49

<u>DESCRIPTION</u>	<u>MANUAL PAGE</u>
<b>*9. LIGHTING DEVICES (HEADLAMPS, TAIL LAMPS, STOP LAMPS, TURN SIGNALS AND LAMPS/FLAGS ON PROJECTING LOADS)</b>	
When Required	51
Anytime	51
<b>*10. STEERING MECHANISMS</b>	
Steering Wheel Lash (Free Play)	52
Steering Column	53
Front Axle Beam (Including Hub)	53
Steering Gear Box (Including Rack and Pinion)	53
Pitman Arm	53
Power Steering	53
Ball and Socket Joints	53
*Tie Rods and Drag Links	54
Nuts	54
Steering System	54
C-Dolly	54
<b>*11. SUSPENSIONS</b>	
Axle Parts/Members	54
Spring Assembly	55
Coil/Rubber Spring/Air Suspension	56
Composite Springs	57
Suspension Connecting Rod, Tracking Component Assembly or Sway Bar Components	58
Adjustable Axle(s)/Sliding Trailer Suspension System	59
<b>*12. TIRES</b>	
Any Tire on Any Front Steering Axle(s) of a Power Unit	59
All Tires Other Than Those Found on the Front Steering Axle(s) of a Powered Unit	61
Lodged Items Between Tires of a Dual Tire Set	62
<b>*13. VAN AND OPEN-TOP TRAILER BODIES</b>	
Upper Rail	62
Lower Rail	63
Floor Crossmembers	63
Side Panels on Fiberglass Reinforced Plywood (FRP) Trailers	63

<u>DESCRIPTION</u>	<u>MANUAL PAGE</u>
<b>*14. WHEELS, RIMS AND HUBS</b>	
Lock or Side Ring	63
Rim Cracks	64
Disc Wheel Cracks	64
Bolt/Stud Holes (Disc Wheels)	64
Spoke Wheel Cracks	64
Tubeless Demountable Adapter Cracks	64
Wheel Fasteners	64
Welds	64
Hubs	65
<b>*15. WINDSHIELD WIPERS</b>	65
<b>*16. BUSES, MOTORCOACHES, PASSENGER VANS OR OTHER PASSENGER-CARRYING VEHICLES – EMERGENCY EXITS/ELECTRICAL CABLES AND SYSTEMS IN ENGINE AND BATTERY COMPARTMENTS/SEATING (TEMPORARY AND AISLE SEATS)</b>	
Emergency Exits	65
Electrical Cables and Systems in Engine and Battery Compartments	66
Loose and/or Temporary Seating	66

**PART III – HAZARDOUS MATERIALS/DANGEROUS GOODS**

<u>DESCRIPTION</u>	<u>MANUAL PAGE</u>
<b>*1. SHIPPING PAPERS</b>	
*General	68
<b>*2. PLACARDING</b>	
*Placards Displayed on a Transport Vehicle	68
<b>*3. BULK PACKAGES</b>	
*Internal Valve (Missing)	68
*Internal Valve (Open)	68
*Bulk Package Authorization	68
*Venting Devices, Manhole Covers, Fill/Inspection Openings/Discharge Valves	68
*Bulk Package Integrity	68
*Supports and Anchoring	68



<u>DESCRIPTION</u>	<u>MANUAL PAGE</u>
<b>*4. TRANSPORT VEHICLE MARKINGS</b>	
*ID Numbers Displayed on a Transport Vehicle	69
<b>*5. POISON INHALATION HAZARD (PIH) MARKINGS</b>	
*Non-Bulk Packaging	69
*Bulk Packaging	69
<b>*6. NON-BULK PACKAGING</b>	
*Package Integrity	69
<b>*7. LOADING AND SECUREMENT</b>	
*Blocking and Bracing	69
Product Compatibility	69
Poison/Edible Materials	70
<b>*8. FORBIDDEN MATERIALS</b>	
*Forbidden Materials	70
<b>*9. RADIOACTIVE MATERIALS – RADIATION LEVELS</b>	
*Measured at Surface of Vehicle	70
<b>*10. EMERGENCY RESPONSE ASSISTANCE PLAN (ERAP) (In Canada Only)</b>	70

**PART IV – ADMINISTRATIVE**

<u>DESCRIPTION</u>	<u>MANUAL PAGE</u>
<b>1. OPERATING AUTHORITY</b>	72
<b>2. INACTIVE/NO USDOT NUMBER</b>	
Inactive USDOT Number	72
No USDOT Number	72
<b>3. MEXICO-DOMICILED CARRIERS OPERATING IN THE U.S.</b>	72
<b>4. U.S. FEDERAL OUT-OF-SERVICE ORDERS</b>	72

## APPENDIX

<u>DESCRIPTION</u>	<u>MANUAL PAGE</u>
<b>*1. NORTH AMERICAN STANDARD INSPECTION LEVELS</b>	75
<b>2. QUALIFYING FOR CVSA DECALS</b>	77
<b>*3. CRITICAL VEHICLE INSPECTION ITEMS</b>	77
<b>4. RAISED LIFT AXLE(S)</b>	78
<b>5. CVSA DECALS ON CARGO TANKS</b>	78
<b>6. VEHICLE INSPECTIONS</b>	78
<b>*7. VEHICLE RE-INSPECTIONS</b>	79
<b>8. REQUIRED REPAIRS FOR OUT-OF-SERVICE NOTICES</b>	79
<b>9. LOCATION OF CVSA DECALS</b>	80
<b>10. CVSA DECAL APPLICATION</b>	81
<b>*11. INSPECTION BULLETINS</b>	82
<b>*12. OPERATIONAL POLICY 15 INSPECTION / REGULATORY GUIDANCE</b>	
*Brake Systems	84
*Cargo Securement	86
Coupling Devices	88
Driveline/Driveshaft	88
Lighting Systems	88
Steering Mechanisms	89
Suspension	90
*Tires	91
Wheels, Rims and Hubs	92
*Miscellaneous (Windshield, Rear Impact Guards, Oil and Grease Leaks)	92

## Part I

### NORTH AMERICAN STANDARD DRIVER OUT-OF-SERVICE CRITERIA

#### POLICY STATEMENT

The purpose of this part is to identify violations that render the commercial motor vehicle operator unqualified to drive or out of service. The necessity for all enforcement personnel to implement and adhere to these standards is: (1) a matter of law; (2) perceived as necessary by the society we are charged with protecting; and (3) a professional obligation if substantial enhancement in the safety of commercial motor vehicle operators is to be achieved.

Except where state, provincial, territorial or federal laws preclude enforcement of a named item, motor carrier safety enforcement personnel and their jurisdictions shall comply with these out-of-service violation standards.

**OUT-OF-SERVICE VIOLATION:** Violations under this category preclude further operation of a commercial motor vehicle by its driver for a specified period of time or for some violations until a required condition is met. An example of the former standard is hours-of-service violations.

1. **DRIVER'S AGE**

Is not at least 21 years of age. (391.11(b)(1), see exemptions 390.3(f) and 391.2) **Declare driver out of service.**

2. **OPERATOR'S/CHAUFFEUR'S LICENSE OR PERMIT (NON-CDL)**

a. Vehicle 26,000 lbs. or less GVWR not designed to transport 16 or more passengers or placarded loads of hazardous materials.

(1) Is not licensed for the type of vehicle being operated. (391.11(b)(5)) **Declare driver out of service.** (*Out-of-service action to be initiated only upon home jurisdiction license verification.*)

(2) Operating a non-CDL required commercial motor vehicle with driving privileges revoked, suspended, cancelled or otherwise disqualified. (391.15(a)) **Declare driver out of service.** (*Out-of-service action to be initiated if a driver's license is suspended in a jurisdiction for any safety-related or unknown reason.*)

b. Endorsements and Restrictions

Operating a commercial motor vehicle without proper endorsement or in violation of restrictions. (391.11(b)(5)) **Declare driver out of service.**

**NOTE:** Canadian operator's license endorsements are included in the class. Transporting dangerous goods requires a training certificate. **Declare driver out of service if not in possession.**

**NOTE:** A Mexican Licencia Federal Class B or E issued on or after Feb. 25, 2016, requires a doubles and/or hazardous materials endorsement(s). If the issued date is before Feb. 25, 2016, endorsements are included in the class. **Declare driver out of service if not in possession.**

3. **COMMERCIAL DRIVER'S LICENSE (CDL)**

a. License

(1) Does not possess a valid CDL issued by his/her state or jurisdiction of domicile. (383.23(a)(2)) **Declare driver out of service.** (*Out-of-service action to be initiated only upon home jurisdiction license verification.*)

(2) Operating a CDL-required commercial motor vehicle with driving privileges revoked, suspended, cancelled or otherwise disqualified. (383.51(a)) **Declare driver out of service.** (*Out-of-service action to be initiated if a driver's license is suspended in a jurisdiction for any safety-related or unknown reason.*)

**NOTE:** Canadian operators not possessing a valid provincial or territorial license of the correct class. **Declare driver out of service.**

**NOTE:** Mexican operators who do not possess a valid Licencia Federal. (Can be recognized by the words “Licencia Federal Conductor” near the top of the card. Mexican state driver licenses are not valid for operating a commercial motor vehicle that requires a CDL in the U.S. and Canada.) **Declare driver out of service.**

b. Commercial Learner's Permit (CLP)

- (1) Is not accompanied by the holder of a valid CDL. (383.25(a)(1)) **Declare driver out of service.**
- (2) Does not hold a valid automobile driver’s license or have a valid operator’s status allowed by licensing jurisdiction. (383.25(a)(2)) **Declare driver out of service.**
- (3) Operating a commercial motor vehicle transporting hazardous materials as defined in 383.5. (383.25(a)(6)) **Declare driver out of service.**
- (4) Operating a commercial motor vehicle transporting passengers requiring the passenger (P) or school bus (S) endorsement(s). (383.25(a)(5)(i) or 383.25(a)(5)(ii) for school buses) **Declare driver out of service.**

c. Endorsements and Restrictions

Operating a commercial motor vehicle without proper endorsements or in violation of restrictions. (383.23(a)(2)) **Declare driver out of service.**

**NOTE:** Canadian operator’s license endorsements are included in the class. Transporting dangerous goods requires a training certificate. **Declare driver out of service if not in possession.**

**NOTE:** A Mexican Licencia Federal Class B or E issued on or after Feb. 25, 2016, requires a doubles and/or hazardous materials endorsement(s). If the issued date is before Feb. 25, 2016, endorsements are included in the class. **Declare driver out of service if not in possession.**

d. Classification

Does not possess proper class of license for vehicle being operated. (383.91(a)) **Declare driver out of service.**

**\*4. DRIVER MEDICAL/PHYSICAL REQUIREMENTS**

\*a. Skill Performance Evaluation Certificate

No skill performance evaluation in possession, when required or when operating a commercial motor vehicle without complying with the requirements indicated on the skill performance evaluation. (391.49(j)) **Declare driver out of service.**

b. Medical Certificate

- (1) Operating a commercial motor vehicle without corrective lenses or hearing aid as indicated on the driver's medical certificate. (391.11(b)(4)) **Declare driver out of service.**
- (2) When an inspector has knowledge and/or evidence that a driver is/is not in possession of a valid medical certificate, and is not in possession of any and all required exemptions for the following conditions: vision, hearing, insulin-using diabetes, epilepsy or any other condition which is likely to cause loss of consciousness or any loss of ability to control a commercial motor vehicle. (391.41(a)(1)) **Declare driver out of service.**
- (3) Operating a passenger-carrying vehicle without a valid medical certificate in possession or on file with the state driver licensing agency when medical certification is required. (391.41(a)) **Declare driver out of service.**

**NOTE:** A driver with a valid CDL response that does not contain any medical certification from the state driver licensing agency should be considered to have their medical certificate on file.

***Inspection Bulletin 2015-04 – Enforcement of Medical Examiner's Certificate Integration with the Commercial Driver's License***

- (4) Operating a property-carrying vehicle without a valid medical certificate in possession or on file with the state driver licensing agency. If the driver fails to produce a medical certificate or has an expired medical certificate, and has a previous history of either failing to produce a medical certificate, or having an expired medical certificate. (391.41(a)) **Declare driver out of service.**
- NOTE:** A driver with a valid CDL response that does not contain any medical certification from the state driver licensing agency should be considered to have their medical certificate on file.
- (5) Operating a commercial motor vehicle with a fraudulent medical certificate. (390.35) **Declare driver out of service.**
  - (6) Operating a CDL-required passenger-carrying or property-carrying vehicle that is non-excepted; and the driver has self-certified as excepted interstate or excepted intrastate, and as excepted would not be required by the state driver licensing agency to submit their medical certification, without a valid medical certificate in possession or on file with the state driver licensing agency. (391.11(b)(4)) **Declare driver out of service.**

**NOTE:** A Canadian driver operating a commercial motor vehicle in the U.S. presenting a Class 5 license from any jurisdiction, a Class D or G from Ontario, Class 3 from Alberta or Class 3 from New Brunswick shall also possess other evidence of compliance with medical requirements (e.g., certificate, endorsement, etc.).

**NOTE:** Mexican operators possessing a valid Licencia Federal de Conductor of the proper class includes a valid medical certificate.

***Inspection Bulletin 2016-01 – Update: Canadian Driver’s Licenses and Required Proof of Medical Certification***

***Inspection Bulletin 2017-04 – Medical Certification Information Available in Nlets***

**5. SICKNESS**

When so impaired that the driver should not continue the trip. (392.3) **Declare driver out of service until no longer impaired.**

**6. FATIGUE**

When a driver operates a commercial motor vehicle while his/her ability or alertness is so impaired, or so likely to become impaired, through fatigue as to make it unsafe for him/her to begin or continue to operate the commercial motor vehicle. (392.3) **Declare driver out of service until no longer fatigued.**

**7. DRUGS AND OTHER SUBSTANCES; AS IDENTIFIED UNDER SECTION 392.4(a)**

a. Shall not be in possession

Is in possession. (392.4(a))

**Declare driver out of service for twenty-four (24) consecutive hours.**

b. Shall not be under the influence

Is under the influence, with probable cause. (392.4(a))

**Declare driver out of service for twenty-four (24) consecutive hours.**

**8. INTOXICATING BEVERAGES**

a. Under the influence

Under the influence of intoxicating beverage, consumes an intoxicating beverage regardless of its alcohol content or have any measured alcohol concentration or any detected presence of alcohol while on duty, or operating or in physical control of a commercial motor vehicle. (Consumption - 392.5(a)(1) or Presence/Influence - 392.5(a)(2)) **Declare driver out of service for twenty-four (24) consecutive hours.**

b. Be on duty or operate

Be on duty or operate a commercial motor vehicle while the driver possesses an intoxicating beverage, regardless of its alcohol content. (Possession - 392.5(a)(3))

**Declare driver out of service for twenty-four (24) consecutive hours.**

c. Out-of-service order violation

Driver violating any roadside out-of-service order regarding intoxicating beverages. (392.5(c)(2)) **Declare driver out of service for twenty-four (24) consecutive hours.**

**NOTE:** The driver would not be **declared out of service** if the driver has taken time off equivalent to the original out-of-service order.

9. DRIVER'S RECORD OF DUTY STATUS – U.S.

a. Property-Carrying Vehicles (395.3)

(1) 11-Hour Rule (See Footnotes 3, 4, 6 and 8)

Driving more than eleven (11) hours following ten (10) consecutive hours off duty. (395.3(a)(3)(i)) **Declare driver out of service until such time as eligibility to drive is re-established.**

(2) 14-Hour Rule (See Footnotes 3, 4, 5, 6 and 8)

Driving beyond the fourteenth (14) hour after coming on duty following ten (10) consecutive hours off duty. (395.3(a)(2)) **Declare driver out of service until such time as eligibility to drive is re-established.**

(3) 60/70-Hour Rule (See Footnotes 3, 4 and 7)

Driving after being on duty more than sixty (60) hours in seven (7) consecutive days or seventy (70) hours in eight (8) consecutive days. (60-Hour Rule - 395.3(b)(1) or 70-Hour Rule - 395.3(b)(2)) **Declare driver out of service until such time as eligibility to drive is re-established.**

(4) No Record of Duty Status (See Footnotes 11, 12 and 14)

No record of duty status in possession when one is required. (395.8(a)(1)) **Declare driver out of service for ten (10) consecutive hours.**

(5) No Previous 7 Days (See Footnotes 2 and 10)

Failing to have in possession a record of duty status for the previous seven (7) consecutive days. (395.8(k)(2), see exception 395.13(b)(3)) **Declare driver out of service for ten (10) consecutive hours.**

(6) False Record of Duty Status (See Footnote 13)

A required record of duty status that does not accurately reflect the driver's actual activities and duty status (including time and location of each duty status change and the time spent in each duty status) in an apparent attempt to conceal a violation of an hours-of-service limitation. (395.8(e)) **Declare driver out of service for ten (10) consecutive hours.**



b. Passenger-Carrying Vehicles (395.5)

(1) 10-Hour Rule (See Footnotes 3, 4 and 8)

Driving more than ten (10) hours following eight (8) consecutive hours off duty. (395.5(a)(1)) **Declare driver out of service until such time as eligibility to drive is re-established.**

(2) 15-Hour Rule (See Footnotes 3, 4 and 8)

Driving for any period after having been on duty fifteen (15) hours following eight (8) consecutive hours off duty. (395.5(a)(2)) **Declare driver out of service until such time as eligibility to drive is re-established.**

(3) 60/70-Hour Rule (See Footnotes 3 and 4)

Driving after being on duty more than sixty (60) hours in seven (7) consecutive days or seventy (70) hours in eight (8) consecutive days. (60-Hour Rule - 395.5(b)(1) or 70-Hour Rule - 395.5(b)(2)) **Declare driver out of service until such time as eligibility to drive is re-established.**

(4) No Record of Duty Status (See Footnotes 11, 12 and 14)

No record of duty status in possession when one is required. (395.8(a)) **Declare driver out of service for eight (8) consecutive hours.**

(5) No Previous 7 Days (See Footnotes 2 and 10)

Failing to have in possession a record of duty status for the previous seven (7) consecutive days. (395.8(k)(2), see exception 395.13(b)(3)) **Declare driver out of service for eight (8) consecutive hours.**

(6) False Record of Duty Status (See Footnote 13)

A required record of duty status that does not accurately reflect the driver's actual activities and duty status (including time and location of each duty status change and the time spent in each duty status) in an apparent attempt to conceal a violation of an hours-of-service limitation. (395.8(e)) **Declare driver out of service for eight (8) consecutive hours.**

c. Hours of Service Out-of-Service Order (See Footnote 9)

Driver violating any roadside out-of-service order regarding hours-of-service. (395.13(d)(1)) **Declare driver out of service for ten (10) consecutive hours.**

---

**Footnotes for driver's record of duty status – U.S.**

1. Removed and reserved.
2. Exception (395.13(b)(3)). A driver failing only to have possession of a record of duty status current on the day of examination and the prior day, but has completed records of duty status up to that time (previous six (6) days) will be given the opportunity to make the duty status record current.
3. Drivers must comply with the hours-of-service rules of the country (Canada, United States or Mexico) in which the driver is operating (driving).
4. Drivers operating in the state of Alaska (395.1(h)).
  - a. Property-Carrying Commercial Motor Vehicle - fifteen (15) hours driving time and twenty (20) hours on duty time following ten (10) hours off duty. Seventy (70) hours in seven (7) consecutive days and eighty (80) hours in eight (8) consecutive days.
  - b. Passenger-Carrying Commercial Motor Vehicle - fifteen (15) hours driving time and twenty (20) hours on duty time following eight (8) hours off duty. Seventy (70) hours in seven (7) consecutive days and eighty (80) hours in eight (8) consecutive days.
5. Exception (395.1(o)). A property-carrying driver is allowed one (1) sixteen (16) hour on duty day within the current seven (7) or eight (8) consecutive day period provided the driver has returned to the driver's normal work reporting location and the carrier released the driver from duty at that location for the previous five (5) duty tours the driver has worked.

**NOTE:** The driver may have more than one (1) sixteen (16) hour on duty day within the previous seven (7) or eight (8) day calendar period in circumstances when there is a valid thirty-four (34) hour restart.
6. Exception (395.1(e)(2)). A short-haul property-carrying driver, not requiring a CDL, and within a 150 air-mile radius is allowed two (2) sixteen (16) hour on duty days within any seven (7) consecutive day period provided the driver has returned to the driver's normal work reporting location at the end of each duty tour. The motor carrier that employs the driver must maintain and retain accurate and true time records for (six) 6 months. See 395.1(e)(2)(i-ix) for all provisions of the exception.

**NOTE:** Drivers taking advantage of this exception cannot use the provisions of 395.1(e)(1) [100 air-mile radius], (g) [Sleeper Berths] and (o) [one 16-hour duty tour].
7. 34 Hour Restart (395.3(c)(1) or (2)). Any period of seven (7) or eight (8) consecutive days may end with the beginning of any off duty period of thirty-four (34) or more consecutive hours.
8. Travel Time (395.1(j)(1) and (2)). When a driver at the direction of the motor carrier is traveling, but has no direct responsibility to the carrier, the time is counted as on-duty time unless the driver is afforded at least (for property-carrying vehicles) ten (10) or (for passenger-carrying vehicles) eight (8) consecutive hours off duty when arriving at the destination. In this case the driver is off duty for the entire period.

9. The driver would not be declared out of service if the driver has taken time off equivalent to the original out-of-service order.
10. A driver who utilizes an electronic device other than those described in 395.15 shall not be declared out of service if the driver has the ability to print and sign previously completed record of duty status that comply with 395.8 upon demand.

***Inspection Bulletin 2012-05 – Automatic On-Board Recording Devices (AOBRDs)***

11. If a driver/carrier is using an electronic logging device that is not authorized by the Federal Motor Carrier Safety Administration per 395.22(a), the driver/carrier is considered to have no record of duty status.
12. If a driver is unable to produce and transfer the data electronically from an electronic logging device to an authorized safety official per 395.24(d) or produce the output via display, print out as required, or paper record of duty status as required during a malfunction, the driver is considered to have no record of duty status. If a driver is unable to produce hours-of-service data from an automatic on-board recording device to an authorized safety official as required by 395.15(b), the driver is considered to have no record of duty status.
13. If a driver indicates use of a special driving category as defined by 395.28(a) when not involved in that activity, the driver's record of duty status is considered to be false.
14. If a driver is required to have an electronic logging device and the vehicle is not equipped with an electronic logging device (or an automatic on-board recording device until Dec. 17, 2019), the driver is considered to have no record of duty status.

***Inspection Bulletin 2017-05 – Handheld and Electronic Logging Devices (ELDs)***

---

**10. DRIVER'S RECORD OF DUTY STATUS – Canada**

a. Driver Impairment

Driver's faculties are impaired to the point where it is unsafe for the driver to drive, or driving would likely jeopardize safety. **Declare driver out of service for ten (10) consecutive hours.**

b. 13-Hour Rule (See Footnotes 1, 3 and 4)

- (1) Driving more than thirteen (13) hours following eight (8) consecutive hours off duty. **Declare driver out of service for eight (8) consecutive hours.**
- (2) Driving more than thirteen (13) hours in a day. **Declare driver out of service for ten (10) consecutive hours.**

c. 14-Hour Rule (See Footnotes 1, 3 and 4)

- (1) Driving for any period after having been on duty fourteen (14) hours following eight (8) consecutive hours off duty. **Declare driver out of service for eight (8) consecutive hours.**
- (2) Driving for any period after having been on duty fourteen (14) hours in a day. **Declare driver out of service for ten (10) consecutive hours.**

d. 16-Hour Rule (See Footnotes 1 and 4)

Driving after sixteen (16) hours of elapsed time between mandatory periods of off duty time. **Declare driver out of service for eight (8) consecutive hours.**

e. 70/120-Hour Rules (See Footnotes 1, 3, 4 and 5)

Driving after being on duty more than seventy (70) hours in seven (7) consecutive days or one hundred and twenty (120) hours in fourteen (14) consecutive days. **Declare driver out of service until such time as eligibility to drive is re-established.**

f. 10-Hour Off Duty Rule (See Footnote 1)

Driver fails to take ten (10) hours off duty in a day. **Declare driver out of service until such time as eligibility to drive is re-established.**

g. 24 Hours Off (See Footnote 1)

Driver fails to take twenty-four (24) hours off duty in the previous fourteen (14) days. **Declare driver out of service for twenty-four (24) consecutive hours.**

h. No Daily Log (See Footnote 2)

The driver is unable or refuses to produce a daily log for the current trip, a copy of the daily logs for the previous fourteen (14) consecutive days or any supporting documents relevant to the current trip. **Declare driver out of service for seventy-two (72) consecutive hours.**

i. False Log (See Footnote 1)

A daily log that does not accurately reflect the driver's actual activities and duty status (including time and location of each duty status change and the time spent in each duty status) in an apparent attempt to conceal a violation of an hours-of-service limitation. **Declare driver out of service for seventy-two (72) consecutive hours.**

---

***Footnotes for driver's record of duty status – Canada***

1. Sleeper Berth Operations
  - a. Drivers involved in sleeper berth operations (sleeper teams) declared out of service for Hours-of-Service violations may be replaced by a co-driver, if the co-driver has hours available to drive.
  - b. A solo driver using a sleeper berth to obtain rest who exceeds the hours-of-service limitations shall be declared out of service until said driver has hours available to drive.
2. A driver failing only to have possession of a daily log current on the day of examination and/or the prior day, but has completed required daily logs up to that time will be given the opportunity to make the daily log current.
3. Drivers must comply with the hours-of-service rules of the country (Canada, United States or Mexico) in which the driver is operating (driving).
4. Drivers operating north of the 60th parallel may not drive after accumulating fifteen (15) hours driving time, eighteen (18) hours on duty time, twenty (20) hours of elapsed time between mandatory periods of off duty time, eighty (80) hours in seven (7) consecutive days or one hundred and twenty (120) hours in fourteen (14) days.
5. When applying the one hundred and twenty (120) hours in a fourteen (14) consecutive day period, drivers must take twenty-four (24) consecutive hours off duty prior to accumulating more than seventy (70) hours on duty (prior to accumulating more than eighty (80) hours on duty north of 60th parallel).

11. DRIVER'S RECORD OF DUTY STATUS – Mexico

a. Daytime Working Day (6:00-20:00)

Driving more than eight (8) hours in the daytime working day; it can also be increased up to three (3) more hours during three (3) non-consecutive days per week. **It is considered that the driver must not resume his/her work until the beginning of the following daytime working day. For each working day, the driver must have at least a half-hour break.**

b. Daytime Working Week (6:00-20:00)

Driving after being on duty more than fifty-four (54) hours in the daytime working week during seven (7) consecutive days, in which there were half-hour breaks during each working day. **It is considered that the driver must not resume his/her work until having at least twenty-four (24) hours of rest.**

c. Night Working Day (20:00-6:00)

Driving more than seven (7) hours in the night working day; it can also be increased up to three (3) more hours during three (3) non-consecutive days per week. **It is considered that the driver must not resume his/her work until the beginning of the following night working day. For each working day, the driver must have at least a half-hour break.**

d. Night Working Week (20:00-6:00)

Driving after being on duty more than forty-eight (48) hours in the night working week during seven (7) consecutive days, in which there were half-hour breaks during each working day. **It is considered that the driver must not resume his/her work until having at least twenty-four (24) hours of rest.**

e. Mixed Working Day (periods between the daytime and night working days; 3 1/2 hour maximum in the night working day)

Driving more than seven and a half (7 1/2) hours in the mixed working day; it can also be increased up to three (3) more hours during three (3) non-consecutive days per week. **It is considered that the driver must not resume his/her work until the beginning of the following mixed working day. For each working day, the driver must have at least a half-hour break.**

f. Mixed Working Week (periods between the daytime and night working days; 3 1/2 hour maximum per night working day)

Driving after being on duty more than fifty-one (51) hours in the night working week during seven (7) consecutive days, in which there were half-hour breaks during each working day. **It is considered that the driver must not resume his/her work until having at least twenty-four (24) hours of rest.**

g. No Record of Duty Status (Log Book)

No record of duty status in possession when one is required. **It is considered that the driver must not resume his/her work until the beginning of the following working day.**

h. No Previous 7 Days

Failing to have in possession a record of duty status for the previous seven (7) consecutive days. **It is considered that the driver must not resume his/her work until having at least twenty-four (24) hours of rest.**

i. False Record of Duty Status (Log Book)

A required record of duty status that does not accurately reflect the driver's actual activities and duty status (including time and location of each duty status change and the time spent in each duty status) in an apparent attempt to conceal a violation of an hours-of-service limitation. **It is considered that the driver must not resume his/her work until the beginning of the following working day or until having twenty-four (24) hours of rest in the working week.**

**\*Part II**

**NORTH AMERICAN STANDARD VEHICLE  
OUT-OF-SERVICE CRITERIA**

**\*POLICY STATEMENT**

The purpose of this part is to identify critical vehicle inspection items and provide criteria for declaring vehicles out of service subsequent to a safety inspection.

Except where state, provincial, territorial or federal laws preclude enforcement of a named item, motor carrier safety enforcement personnel and their jurisdictions shall comply with these out-of-service violation standards.

**NOTE: Decal Qualification:** Each vehicle (motorcoach, school bus, other bus, truck, truck tractor, semi-trailer, trailer, converter dollies, etc.) used singularly or in combination may qualify for a CVSA decal if it passes inspection, and a CVSA decal shall be applied. "Pass Inspection" means that during a North American Standard Level I or Level V Inspection no defects are found in the critical vehicle inspection items.

For the purpose of a CVSA decal issuance, if no violation is detected during a North American Standard Level I or Level V Inspection due to a hidden part, other than pushrod stroke measurements, of the listed critical vehicle inspection items, then a CVSA decal shall be applied. However, if more than 20 percent of pushrod travel on exposed pushrods cannot be measured, then a CVSA decal shall not be applied. If a brake measurement was not obtained due to a hidden component, then "NM" shall be documented for that wheel-end brake as well as being noted on the inspection report that it was not measured due to a hidden component. Brakes not measured will be considered compliant and still included in the 20 percent calculation. An inspector can still apply a CVSA decal even though his/her jurisdiction does not allow for the inspection of gaseous fuel systems.

\*The decal criteria applies only to the condition of the vehicle, not the driver. It is possible for a driver to be out of service and still have vehicle(s) qualify for a decal. If each vehicle, whether used singly or in a combination, passes inspection, any expired CVSA decal shall be removed and a current CVSA decal shall be affixed.

**OUT OF SERVICE:** Authorized personnel shall declare out of service any commercial motor vehicle which by reason of its mechanical condition or loading would be likely to cause a crash or breakdown. An out-of-service vehicle sticker shall be used to declare vehicles out of service as per jurisdictional regulations. No motor carrier shall require nor shall any person operate, or any inspector release any commercial motor vehicle declared out of service until all repairs required by the out-of-service notice have been satisfactorily completed to where a violation no longer exists.

When a vehicle is declared out of service for a condition resulting from an accumulation of violations, all violations that contributed to the specific out-of-service condition must be repaired (e.g., a vehicle, or vehicles in combination declared out of service for 20 percent defective brake violations must have all 20 percent defective brake violations repaired prior to being released; or, a vehicle declared out of service for two tires at less than 1/32 inch (0.8 millimeter) tread depth must have both tire violations repaired prior to the vehicle being released, etc.). Once all of the contributing out-of-service violations



have been repaired on any vehicle in a combination, that specific vehicle in the combination is no longer considered to be out of service.

An out-of-service condition cannot be corrected by creating a new violation (e.g., if a vehicle is declared out of service for three missing wheel fasteners on one wheel, wheel fasteners from other wheels cannot be removed to correct this out-of-service condition, etc.).

When vehicles in combination are declared out of service for 20 percent defective brake violations, any vehicle within the combination that does not contain a brake violation that contributed to the 20 percent defective brake out-of-service condition is allowed to proceed providing it does not contain any other out-of-service conditions.

No person shall remove the out-of-service vehicle sticker from any commercial motor vehicle prior to completion of all repairs required by the out-of-service notice.

Violations, other than out-of-service conditions, detected during the inspection process will not preclude the completion of the current trip or dispatch. However, such violations must be corrected or repaired prior to re-dispatch.

A critical vehicle inspection item violation(s) (out of service or otherwise) noted during a CVSA Level I Inspection that is successfully repaired on-site and re-inspected by the same inspector at the same inspection location will qualify for a CVSA decal as long as all previously noted critical vehicle inspection item violation(s) have been properly repaired. In such instances, only a re-inspection of the repaired violation(s) shall be done with decal(s) being applied to the vehicle(s) and properly noted upon the original inspection.

Any vehicle that is repaired off-site or inspected by a different inspector shall be required to have a complete inspection conducted in order to obtain a CVSA decal.

These criteria are neither suited nor intended to serve as vehicle maintenance or performance standards.

**\*1. BRAKE SYSTEMS**

a. Defective Brakes

The number of defective brakes is equal to or greater than 20 percent of the service brakes on the vehicle or combination. A defective brake includes any brake that meets one of the following conditions. (396.3(a)(1))

**NOTE:** Steering axle brakes under “Front Steering Axle(s) Brakes,” are to be included in the 20 percent criterion.

Defective Brake Chart (below) shall be used in determining when a vehicle/combination is to be declared out of service.

Total Number of Brakes Required to be on a Vehicle Combination	Total Number of Defective Brakes Necessary to Declare the Vehicle or Combination Out of Service
4	1
6	2
8	2
10	2
12	3
14	3
16	4
18	4
20	4
22	5
**	

**\*\* Vehicle Combination with More Than 22 Brakes – Total Number of Defective Brakes Necessary to Declare the Vehicle Combination Out of Service.**

Determine the number of defective brakes required by using 20 percent of the total number of brakes on the vehicle or combination (e.g.,  $24 \times 0.2 = 4.8$  brakes). Round all fractions up to the next whole number (e.g., 4.8 brakes = 5 required defective brakes).

- (1) Absence of effective braking action upon application of the service brakes (such as any brake lining/pad failing to move or contact braking surface upon application). (393.48(a))

- (2) Audible air leak at air chamber. (e.g., ruptured diaphragm, loose chamber clamp, etc.) (396.3(a)(1))

**NOTE:** Refer to “Air Loss Rate.”

- (3) Missing brake on any axle required to have brakes. (393.42(a))

- (4) Brake Adjustment Limits. Bring reservoir pressure between 90-100 psi (620-690 kPa), turn engine off and then fully apply the brakes. All brake measurements shall be made in 1/8 inch (3.2 mm) increments.

(a) One brake at 1/4 inch (6.4 mm) or more beyond the adjustment limit. (e.g., Type 30 clamp type air chamber pushrod measured at 2 1/4 inches (57.2 mm) would be 1 defective brake.) (393.47(e))

(b) A brake found at 1/8 inch (3.2 mm) beyond the brake adjustment limit shall be considered 0.5 (1/2) a defective brake for determining the number of defective brakes per the 20 percent defective brake criterion. (e.g., Type 30 clamp type brake chamber pushrods measure – 2 at 2 1/8 inches (54.0 mm) equal 1 defective brake.) (393.47(e))

**NOTE:** When the vehicle, or combination of vehicles, is declared out of service for 20 percent brake violations, all brakes found beyond the brake adjustment limit must be repaired.

**NOTE:** When calculating/determining the number of defective brakes, round all fractions down to the next whole number (e.g., 4.5 brake violations = 4 defective brakes).

(c) Any wedge brake where the combined brake lining movement of both top and bottom shoes exceeds 1/8 inch (3.2 mm). (393.47(f))

COMMERCIAL VEHICLE SAFETY ALLIANCE  
NORTH AMERICAN STANDARD OUT-OF-SERVICE CRITERIA  
REFERENCE CHARTS

Reference: "Defective Brakes" of Part II of the North American Standard Out-of-Service Criteria

Brake Adjustment: Shall not exceed those specifications contained hereunder relating to "Brake Adjustment Limit." (Dimensions are in inches/millimeters.)

CLAMP TYPE BRAKE CHAMBER DATA

Type	Outside Diameter	Brake Adjustment Limit	Half Defect Limit	Full Defect Limit
6	4 1/2 (114 mm)	1 1/4 (31.8 mm)	1 3/8 (34.9 mm)	1 1/2 (38.1 mm)
9	5 1/4 (133 mm)	1 3/8 (34.9 mm)	1 1/2 (38.1 mm)	1 5/8 (41.3 mm)
12	5 11/16 (145 mm)	1 3/8 (34.9 mm)	1 1/2 (38.1 mm)	1 5/8 (41.3 mm)
16	6 3/8 (162 mm)	1 3/4 (44.5 mm)	1 7/8 (47.6 mm)	2 (50.8 mm)
20	6 25/32 (172 mm)	1 3/4 (44.5 mm)	1 7/8 (47.6 mm)	2 (50.8 mm)
24	7 7/32 (184 mm)	1 3/4 (44.5 mm)	1 7/8 (47.6 mm)	2 (50.8 mm)
30	8 3/32 (206 mm)	2 (50.8 mm)	2 1/8 (54.0 mm)	2 1/4 (57.2 mm)
36	9 (229 mm)	2 1/4 (57.2 mm)	2 3/8 (60.3 mm)	2 1/2 (63.5 mm)

**NOTE:** Service chambers with housings that are permanently crimped and sealed together are considered clamp type chambers even though they do not have a separate clamp band.

**NOTE:** A brake found at the adjustment limit is not a defect for the purposes of the 20 percent rule.

LONG STROKE CLAMP TYPE BRAKE CHAMBER DATA

Type	Outside Diameter	Brake Adjustment Limit	Half Defect Limit	Full Defect Limit
12	5 11/16 (145 mm)	1 3/4 (44.5 mm)	1 7/8 (47.6 mm)	2 (50.8 mm)
16	6 3/8 (162 mm)	2 (50.8 mm)	2 1/8 (54.0 mm)	2 1/4 (57.2 mm)
20 (2 1/2" Rated Stroke)	6 25/32 (172 mm)	2 (50.8 mm)	2 1/8 (54.0 mm)	2 1/4 (57.2 mm)
20 (3" Rated Stroke)	6 25/32 (172 mm)	2 1/2 (63.5 mm)	2 5/8 (66.7 mm)	2 3/4 (69.9 mm)
24 (2 1/2" Rated Stroke)	7 7/32 (184 mm)	2 (50.8 mm)	2 1/8 (54.0 mm)	2 1/4 (57.2 mm)
24 (3" Rated Stroke)	7 7/32 (184 mm)	2 1/2 (63.5 mm)	2 5/8 (66.7 mm)	2 3/4 (69.9 mm)
30	8 3/32 (206 mm)	2 1/2 (63.5 mm)	2 5/8 (66.7 mm)	2 3/4 (69.9 mm)

**NOTE:** Rated stroke is indicated on a tag and is only used to identify chamber size.

**NOTE:** Service chambers with housings that are permanently crimped and sealed together are considered clamp type chambers even though they do not have a separate clamp band.

**NOTE:** A brake found at the adjustment limit is not a defect for the purposes of the 20 percent rule.

BOLT TYPE BRAKE CHAMBER DATA

Type	Outside Diameter	Brake Adjustment Limit	Half Defect Limit	Full Defect Limit
A	6 15/16 (176 mm)	1 3/8 (34.9 mm)	1 1/2 (38.1 mm)	1 5/8 (41.3 mm)
B	9 3/16 (234 mm)	1 3/4 (44.5 mm)	1 7/8 (47.6 mm)	2 (50.8 mm)
C	8 1/16 (205 mm)	1 3/4 (44.5 mm)	1 7/8 (47.6 mm)	2 (50.8 mm)
D	5 1/4 (133 mm)	1 1/4 (31.8 mm)	1 3/8 (34.9 mm)	1 1/2 (38.1 mm)
E	6 3/16 (157 mm)	1 3/8 (34.9 mm)	1 1/2 (38.1 mm)	1 5/8 (41.3 mm)
F	11 (279 mm)	2 1/4 (57.2 mm)	2 3/8 (60.3 mm)	2 1/2 (63.5 mm)
G	9-7/8 (251 mm)	2 (50.8 mm)	2 1/8 (54.0 mm)	2 1/4 (57.2 mm)

**NOTE:** A brake found at the adjustment limit is not a defect for the purposes of the 20 percent rule.

---

ROTOCHAMBER DATA

Type	Outside Diameter	Brake Adjustment Limit	Half Defect Limit	Full Defect Limit
9	4 9/32 (109 mm)	1 1/2 (38.1 mm)	1 5/8 (41.3 mm)	1 3/4 (44.5 mm)
12	4 13/16 (122 mm)	1 1/2 (38.1 mm)	1 5/8 (41.3 mm)	1 3/4 (44.5 mm)
16	5 13/32 (138 mm)	2 (50.8 mm)	2 1/8 (54.0 mm)	2 1/4 (57.2 mm)
20	5 15/16 (151 mm)	2 (50.8 mm)	2 1/8 (54.0 mm)	2 1/4 (57.2 mm)
24	6 13/32 (163 mm)	2 (50.8 mm)	2 1/8 (54.0 mm)	2 1/4 (57.2 mm)
30	7 1/16 (180 mm)	2 1/4 (57.2 mm)	2 3/8 (60.3 mm)	2 1/2 (63.5 mm)
36	7 5/8 (194 mm)	2 3/4 (69.9 mm)	2 7/8 (73.0 mm)	3 (76.2 mm)
50	8 7/8 (226 mm)	3 (76.2 mm)	3 1/8 (79.4 mm)	3 1/4 (82.6 mm)

**NOTE:** A brake found at the adjustment limit is not a defect for the purposes of the 20 percent rule.

---

DD-3 BRAKE CHAMBER DATA

Type	Outside Diameter	Brake Adjustment Limit	Half Defect Limit	Full Defect Limit
30	8 1/8 (206 mm)	2 1/4 (57.2 mm)	2 3/8 (60.3 mm)	2 1/2 (63.5 mm)

**NOTE:** This chamber has three air lines and is found on motorcoaches.

**NOTE:** A brake found at the adjustment limit is not a defect for the purposes of the 20 percent rule.

---

WEDGE BRAKE DATA

The combined movement of both brake shoe lining scribe marks shall not exceed 1/8 inch (3.2 mm).

(5) Drum (Cam-Type and Wedge) Air Brakes

- (a) Missing or broken brake shoe, lining, return spring (shoe or chamber), anchor pin, spider, cam roller, camshaft, pushrod, yoke, clevis pin, clevis pin retainer (e.g., cotter pin), brake adjuster, parking brake power spring or air chamber mounting bolt. (393.48(a))

**Inspection Bulletin 2006-01 – Camshaft Bushings**

- (b) Loose air chamber, spider or camshaft support bracket. (393.48(a))
- (c) Defective Lining Conditions

- i. Lining cracks or voids that exceed 1/16 inch (1.6 mm) in width observable on the edge of the lining. (393.47(a))

**Operational Policy 15 – Inspection/Regulatory Guidance:  
Regulatory Guidance 1.b.(1) – Cracks/Rust Jacking**

- ii. Portion of a lining segment missing such that a fastening device (rivet or bolt) is exposed when viewing the lining from the edge. (393.47(a))
- iii. Crack that exceeds 1 1/2 inch (38.1 mm) in length. (393.47(a))
- iv. Loose lining segment. (Approximately 1/16 inch (1.6 mm) or more movement.) (393.47(a))
- v. Complete lining segment missing. (393.47(a))
- vi. The friction surface of the brake drum and the brake friction material are contaminated by oil or grease. (393.47(a))

**NOTE:** Refer to “Wheels, Rims and Hubs” if wheel seal is actively leaking.

- vii. Lining thickness less than 1/4 inch (6.4 mm) or worn into the wear indicator if lining is so marked, measured at the shoe center. (393.47(d)(2))

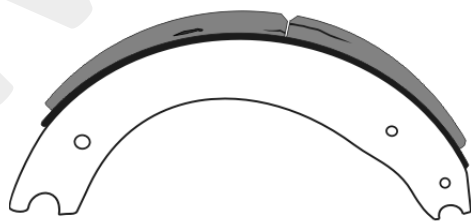

Cracks or voids that exceed 1/16 inch in width.  
Cracks that exceed 1 1/2 inches in length.

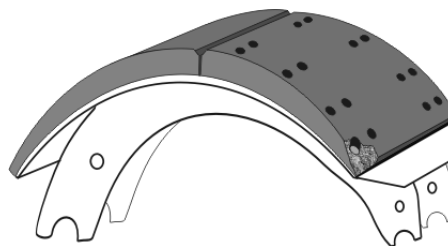

Portion of lining missing that exposes a fastening device.

(6) Air Disc Brakes (Exposed Pushrods and Direct Coupled – Air Chamber to Caliper)

- (a) Missing or broken caliper, brake pad, pad retaining component, pushrod, yoke, clevis pin, clevis pin retainer (e.g., cotter pin), brake adjuster, parking brake power spring, chamber return spring, or air chamber mounting bolt. (393.48(a))
- (b) Loose or missing brake chamber or caliper mounting bolt. (393.48(a))
- (c) Rotor has evidence of metal to metal contact on the friction surface. (393.47(d)(2))
- (d) Rotor has severe rusting on the rotor friction surface on either side (light rusting on the friction surface is normal). (393.48(a))
- (e) The friction surface of the brake rotor and the brake friction material are contaminated by oil or grease. (393.47(a))

**NOTE:** Refer to “Wheels, Rims and Hubs” if wheel seal is actively leaking.

- (f) Brake pad thickness less than 1/16 inch (1.6 mm) or to wear indicator if pad is so marked. (393.47(d)(2))

***\*Inspection Bulletin 2018-04 – Air Disc Brake Inspection***

(7) Hydraulic and Electric Brakes

- (a) Missing or broken caliper, pad retaining component, brake pad, shoe, or lining. (393.48(a))
- (b) Loose or missing brake caliper mounting bolt. (393.48(a))
- (c) Movement of the caliper within the anchor plate, in the direction of wheel rotation, exceeds 1/8 inch (3.2 mm). (393.48(a))

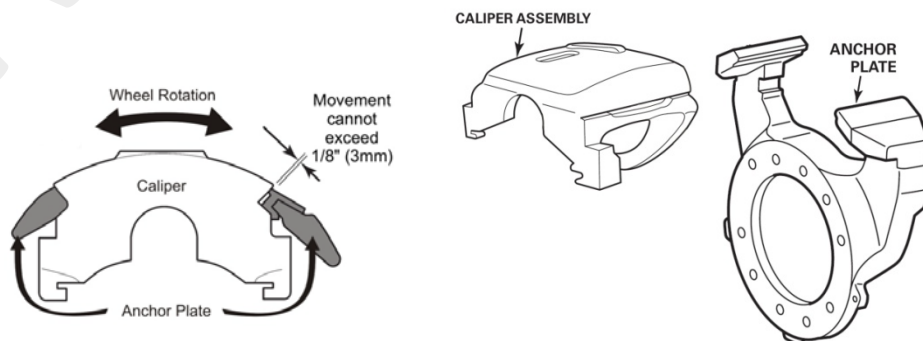

- (d) Rotor or drum has evidence of metal to metal contact on the friction surface. (393.47(d)(2))
  - (e) Rotor has severe rusting on the rotor friction surface on either side (light rusting on the friction surface is normal). (393.48(a))
  - (f) Friction surface of the brake drum or rotor and the brake friction material are contaminated by oil, grease or brake fluid. (393.47(a))
- NOTE:** Refer to “Wheels, Rims and Hubs” if wheel seal is actively leaking.
- (g) Lining or pad with a thickness 1/16 inch (1.6 mm) or less for disc or drum brakes. (393.47(d)(2))

b. Front Steering Axle(s) Brakes

In addition to being included in the 20 percent criterion, the following place a vehicle in an out-of-service condition:

- (1) Any inoperative brake (such as any brake lining/pad failing to move or contact braking surface upon application) or missing brake on either wheel of any steering axle of any vehicle equipped or required to be equipped with steering axle brakes, including the dolly and front axle of a full trailer. This includes tractors required to have steering axle brakes. (Missing - 393.42(a) or Inoperative - 393.48(a))
- (2) Drum (Cam-Type and Wedge) Air Brakes – (Front Steering Brakes)
  - (a) Mismatched air chamber sizes. (393.47(b))
 

**NOTE:** Mismatched air chamber size excludes long stroke air chamber versus regular stroke air chamber and excludes differences in design type such as type 20 clamp versus type 20 rotochamber. A bolt chamber with any other chamber type is a mismatch.
  - (b) Mismatched brake adjuster length. (393.47(c))
  - (c) Defective Lining Conditions
    - i. Lining cracks or voids that exceed 1/16 inch (1.6 mm) in width observable on the edge of the lining. (393.47(a))
 

**Operational Policy 15 – Inspection/Regulatory Guidance:  
Regulatory Guidance 1.b.(1) – Cracks/Rust Jacking**
    - ii. Portion of a lining segment missing such that a fastening device (rivet or bolt) is exposed when viewing the lining from the edge. (393.47(a))



- iii. Crack that exceeds 1 1/2 inch (38.1 mm) in length. (393.47(a))
- iv. Loose lining segment. (Approximately 1/16 inch (1.6 mm) or more movement.) (393.47(a))
- v. Complete lining segment missing. (393.47(a))
- vi. The friction surface of the brake drum and the brake friction material are contaminated by oil or grease. (393.47(a))

**NOTE:** Refer to “Wheels, Rims and Hubs” if wheel seal is actively leaking.

- vii. Lining with a thickness less than 3/16 inch (4.8 mm) for a shoe with a continuous strip of lining or 1/4 inch (6.4 mm) for a shoe with two lining blocks for drum brakes or worn into the wear indicator if lining is so marked. (393.47(d)(1))

(3) Air Disc Brakes (Exposed Pushrods and Direct Coupled – Air Chamber to Caliper) – (Front Steering Axle)

- (a) Mismatched air chamber sizes. (393.47(b))

**NOTE:** Mismatched air chamber size excludes long stroke air chamber versus regular stroke air chamber. A mismatch on an air disc brake exists only when there is measurable difference in air chamber clamp sizes.

- (b) Mismatched brake adjuster length. (393.47(c))
- (c) Missing brake pad. (393.47(a))
- (d) Rotor has evidence of metal to metal contact on the friction surface. (393.47(d)(1))
- (e) Rotor has severe rusting on the rotor friction surface on either side (light rusting on the friction surface is normal). (393.48(a))
- (f) The friction surface of the brake rotor and the brake friction material are contaminated by oil or grease. (393.47(a))

**NOTE:** Refer to “Wheels, Rims and Hubs” if wheel seal is actively leaking.

- (g) Brake pad thickness less than 1/16 inch (1.6 mm) or to wear indicator if lining is so marked. (393.47(d)(1))

- (4) Hydraulic Brakes – (Front Steering Brakes)
- (a) Missing lining or pad. (393.47(a))
  - (b) Loose or missing brake caliper mounting bolt. (393.48(a))
  - (c) Movement of the caliper within the anchor plate, in the direction of wheel rotation, exceeds 1/8 inch (3.2 mm). (393.48(a))
  - (d) Rotor has evidence of metal to metal contact on the friction surface. (393.47(d)(1))
  - (e) Rotor has severe rusting on the rotor friction surface on either side (light rusting on the friction surface is normal). (393.48(a))
  - (f) The friction surface of the brake drum or rotor and the brake friction material are contaminated by oil, grease or brake fluid. (393.47(a))
- NOTE:** Refer to “Wheels, Rims and Hubs” if wheel seal is actively leaking.
- (g) Pad with a thickness 1/16 inch (1.6 mm) or less for disc brakes. (393.47(d)(1))

**End of 20 Percent Brake Criterion**

---

- c. Spring Brake Chambers  
Any non-manufactured holes or cracks in the spring brake housing section of a parking brake. (396.3(a)(1))
- d. Trailer Breakaway and Emergency Braking
  - (1) Missing or inoperable breakaway braking system on a trailer or converter dolly. (393.43(d))
  - (2) A breakaway system not directly attached to the towing vehicle. (393.43(d))
  - (3) On any trailer equipped with spring brakes, more than 25 percent of the spring brakes are inoperative. (393.43(d))
- e. Parking Brake  
No brakes on the vehicle or combination are applied upon actuation of the parking brake control, including driveline hand controlled parking brakes. (393.41)

f. Brake Smoke/Fire

Brake malfunction causing smoke or fire to emit from the wheel end. (393.48(a))

Example: Brake lining continuously in contact with brake drum or rotor.

**NOTE:** This does not include overheating due to severe brake use.

**NOTE:** Refer to “Wheels, Rims and Hubs” as the cause may either be the brakes or a problem in the hub and bearing area.

\*g. Brake Drums or Rotors (Discs)

(1) \*\* Any portion of the drum has any external crack, or has any crack that opens upon brake application. (393.47(a))

\* (2) \*\* Any rotor (disc) with a crack in length of more than 75 percent of the friction surface and passes completely through the rotor to the center vent from either side or completely through a solid rotor or completely through a structural support connecting the rotor friction surfaces. (393.47(a))

\*\* NOTE: Do not confuse short hairline heat check cracks with flexural cracks.



(3) A rotor surface is worn to or through center vents. (393.47(g))

(4) Any portion of the drum or rotor (discs) missing or in danger of falling away. (393.47(a))

h. Air Brake Hose/Tubing

(1) Any damage extending through the reinforcement ply. (393.45(a)) (as per 4 or 5 below)

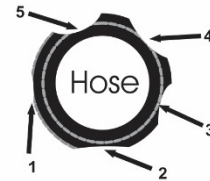
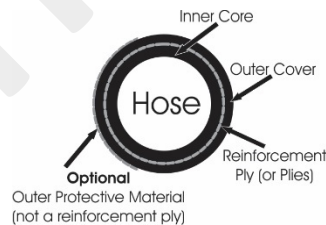

Ref #	Visual Characteristics	OOS Status
1	Wear extends into outer protective material.	Not OOS
2	Wear extends through outer protective material into outer cover.	Not OOS
3	Wear makes reinforcement ply visible, but ply is intact.	Not OOS
4	Reinforcement ply is visible and ply is frayed, severed or cut through.	OOS
5	Wear extends through reinforcement ply.	OOS

**Operational Policy 15 – Inspection/Regulatory Guidance: Regulatory Guidance  
1.b.(2) – Air Hose Violations**

**NOTE:** Rubber impregnated fabric cover is not a reinforcement ply.

**NOTE:** Thermoplastic nylon tube may have braid reinforcement or color difference between cover and inner tube. Exposure of second color is an out-of-service condition.

- (2) Bulge/swelling when air pressure is applied. (393.45(a))
- (3) Audible air leak at other than a proper connection. (393.45(a))

**Inspection Bulletin 2010-05 – MCI Buses with Detroit Diesel Engines**

**Operational Policy 15 – Inspection/Regulatory Guidance: OOS Frequently Asked Questions 1.a.(1) – Proper Connections, 1.a.(2) – Leaks at Fittings**

**Operational Policy 15 – Inspection/Regulatory Guidance: Regulatory Guidance  
1.b.(3) – Air Leaks**

- (4) Improperly joined, such as a splice made by sliding the hose ends over a piece of tubing and clamping the hose to the tube. (393.45(a))
- (5) Damaged by heat, broken or crimped in such a manner as to restrict air flow. (393.45(a))

i. Air Pressure Gauge

Inoperative or defective primary or secondary air pressure gauge. (393.51(c))

j. Low Air Pressure Warning Device

Low air pressure warning device missing, inoperative or does not operate continuously if either the primary or secondary reservoir is 55 psi (379 kPa) and below, or 1/2 of the governor cut-out pressure, whichever is less. (393.51(c))

**NOTE:** If either an audible or visual warning device is working as required, vehicle should not be declared out of service.

k. Air Loss Rate

If an air leak is discovered and either the primary or secondary reservoir pressure is not maintained when: (396.3(a)(1))

- (1) Governor is cut-in;
- (2) Reservoir pressure is between 80-90 psi (551-620 kPa);
- (3) Engine is at idle; and,
- (4) Service brakes are either fully applied or released.

I. Tractor Protection System

Inoperable or missing tractor protection system components, including a tractor protection valve and/or trailer supply valve. (393.43(a) or 393.43(b))

**NOTE:** An inoperative tractor protection system is defined as one of the following conditions:

1. The trailer supply valve fails to close before pressure drops below 20 psi (138 kPa) in either the primary or secondary system.
2. When air escapes from either glad hand when brakes are applied after the tractor protection valve has closed.

***Inspection Bulletin 2010-01 – Tractor Protection Systems***

m. Air Reservoir (Tank)

An air reservoir (tank) separated at either end from the attachment point(s) allowing movement of more than 1 inch (25.4 mm) in any direction. (396.3(a)(1))

n. Air Compressor

(Normally to be inspected when readily visible or when conditions indicate compressor problems.)

- (1) Loose compressor mounting bolts. (396.3(a)(1))
- (2) Cracked, broken or loose pulley. (396.3(a)(1))
- (3) Cracked or broken mounting brackets, braces or adapters. (396.3(a)(1))

o. Hydraulic Brakes

- (1) The fluid level in any master cylinder reservoir is less than 1/4 full or below minimum marking. (396.3(a)(1))

**NOTE:** Normally to be inspected when readily visible or problems are apparent.

- (2) Hydraulic or vacuum lines, hoses or connections are restricted, crimped, broken or damaged through the outer reinforcement ply. (Restricted/Crimped/Broken - 393.45(a) or Damaged - (393.45(b)(2))

**NOTE:** Rubber impregnated fabric cover is not a reinforcement ply.

- (3) Any observable seepage, bulge or swelling on a brake hose under application pressure. (393.45(a))

- (4) Improperly joined, such as a splice made by sliding a hose/tube end over the brake line and clamping the hose to the brake line. (393.45(a))
- (5) Any observable leaking hydraulic fluid in the brake system upon full application. (393.45(a))
- (6) No pedal travel reserve with engine running upon full brake application. (393.40(b))
- (7) Brake power assist unit is inoperative. (396.3(a)(1))
- (8) Hydraulic power brake (HPB) unit is inoperative. (396.3(a)(1))
- (9) Brake failure warning system is missing, inoperative, disconnected, defective or activated while the engine is running with or without brake application. (393.51(b))
- (10) The hydraulic brake backup system is inoperative. (396.3(a)(1))

***Inspection Bulletin 2012-04 – Hydraulic Brake System Inspection and Trailer Inspection Procedures***

p. Vacuum Brakes

- (1) Insufficient vacuum reserve to permit one full brake application after engine is shut off. (393.50(b))
- (2) Vacuum hose(s) or line(s) restricted, abraded (chafed) through outer cover-to-cord ply, crimped, cracked, broken or has collapse of vacuum hose(s) when vacuum is applied. (393.45(b)(2))

q. Performance-Based Brake Test (PBBT)

Failing to develop a total brake force as a percentage of gross vehicle or combination weight of 43.5 or more on an approved PBBT. (393.52(a))

**NOTE:** The out-of-service notice will be satisfactorily completed:

- i. If an approved PBBT is available, the vehicle shall be retested on an approved PBBT and achieve a total brake force as a percentage of gross vehicle or combination weight of 43.5 or more; or
- ii. If an approved PBBT is unavailable, each of the brake fault areas identified on the inspection report shall be inspected and repaired.

**NOTE:** In the United States, an approved PBBT must meet the Federal Motor Carrier Safety Administration functional specifications 65 FR 48799, Aug. 9, 2000.

**\*2. CARGO SECUREMENT**

**\*a. General Securement**

Part(s) of a vehicle or condition of loading such that the spare tire or any part of the load, cargo or dunnage can fall onto the roadway. (Vehicle Components/Dunnage - 392.9(a)(2) or General Cargo - 393.100(b))

**\*b. Articles Not Restrained from Rolling**

Articles of cargo that are likely to roll are not restrained by chocks, wedges, a cradle or other equivalent means to prevent rolling. (393.106(c)(1))

**\*c. Articles Beside Each Other and Secured by Transverse Tiedowns**

Articles of cargo placed beside each other and secured by transverse tiedowns are not in direct contact with each other and are not prevented from shifting towards each other while in transit. (393.106(c)(2))

**\*d. Aggregate Working Load Limit**

When the aggregate working load limit of the securement devices being used is less than 1/2 the weight of the cargo being secured. (393.106(d))

**NOTE:** Equivalent means of securement (e.g., vehicle structures, dunnage, dunnage bags, shoring bars, etc.) may be used to comply; not all cargo must be “tied down” with chains, webbing, wire rope, cordage, etc.

**\*e. Tiedowns for Length – No Front End Structure**

Articles of cargo not blocked or positioned to prevent movement in the forward direction by a headerboard, bulkhead, other cargo that is positioned to prevent movement, or other appropriate blocking devices, is not secured by at least:

(1) One tiedown for articles 5 feet (1.52 m) or less in length, and 1,100 pounds (500 kg) or less in weight. (393.110(b)(1))

(2) Two tiedowns if the article is:

(a) 5 feet (1.52 m) or less in length and more than 1,100 pounds (500 kg) in weight; or, (393.110(b)(2)(i))

(b) Longer than 5 feet (1.52 m) but less than or equal to 10 feet (3.04 m) in length, irrespective of the weight. (393.110(b)(2)(ii))

(3) Two tiedowns if the article is longer than 10 feet (3.04 m) and one additional tiedown for every 10 feet (3.04 m) of article length, or fraction thereof, beyond the first 10 feet (3.04 m) of length. (393.110(b)(3))

**NOTE:** Tiedowns shall be positioned as follows:

i. Tiedowns spaced 10 feet (3.04 m) apart along the length of the vehicle; or,

ii. A tiedown in every 10 foot (3.04 m) segment of the cargo; or,

- iii. To accommodate anchor points or cargo damage considerations, tiedowns may be spaced or grouped at lengths greater or less than 10 feet (3.04 m).

\*f. Tiedowns for Length – Front End Structure

Article(s) of cargo that is blocked, braced or immobilized to prevent movement in the forward direction by a headerboard, bulkhead, other articles which are adequately secured or by an appropriate blocking or immobilization method, is not secured by at least one tiedown for every 10 feet (3.04 m) of article length, or fraction thereof. (393.110(c))

**NOTE:** Tiedowns shall be positioned as follows:

- i. Tiedowns spaced 10 feet (3.04 m) apart along the length of the vehicle; or,
- ii. A tiedown in every 10 foot (3.04 m) segment of the cargo; or,
- iii. To accommodate anchor points or cargo damage considerations, tiedowns may be spaced or grouped at lengths greater or less than 10 feet (3.04 m).

***Operational Policy 15 – Inspection/Regulatory Guidance: Regulatory Guidance 2.b.(1) – Bungee Cord/Tarp Straps***

***Operational Policy 15 – Inspection/Regulatory Guidance: Regulatory Guidance 2.b.(4) – Hay and Straw Bales***

***Operational Policy 15 – Inspection/Regulatory Guidance: Regulatory Guidance 2.b.(5) – Stretch Film and/or Shrink-Wrap***

***Operational Policy 15 – Inspection/Regulatory Guidance: Regulatory Guidance 2.b.(7) – Friction Mats***

g. Logs

Not secured per the commodity specific securement requirements. (393.116)

h. Dressed Lumber or Similar Building Products

Not secured per the commodity specific securement requirements. (393.118)

***\*Operational Policy 15 – Inspection/Regulatory Guidance: Regulatory Guidance 2.b.(8) – Dressed Lumber or Similar Building Products***

i. Metal Coils

Not secured per the commodity specific securement requirements. (393.120)

***Operational Policy 15 – Inspection/Regulatory Guidance: Regulatory Guidance 2.b.(3) – Metal Coil Exemption***

j. Paper Rolls

Not secured per the commodity specific securement requirements. (393.122)



- k. Concrete Pipe  
Not secured per the commodity specific securement requirements. (393.124)
- l. Intermodal Containers  
Not secured per the commodity specific securement requirements. (393.126)

***Inspection Bulletin 2017-02 – Securement of an Intermodal Container on Container Chassis Vehicle***

- m. Automobiles, Light Trucks and Vans  
Not secured per the commodity specific securement requirements. (393.128)
- n. Heavy Vehicles, Equipment and Machinery  
Not secured per the commodity specific securement requirements. (393.130)

***Operational Policy 15 – Inspection/Regulatory Guidance: OOS Frequently Asked Questions 2.a.(1) – Auxiliary Equipment***

- o. Flattened or Crushed Vehicles  
Not secured per the commodity specific securement requirements. (393.132)

***Operational Policy 15 – Inspection/Regulatory Guidance: Regulatory Guidance 2.b.(6) – Cubed/Crushed Cars***

- p. Roll-on/Roll-off or Hook Lift Containers  
Not secured per the commodity specific securement requirements. (393.134)
- q. Large Boulders  
Not secured per the commodity specific securement requirements. (393.136)

---

A tiedown or anchor point that is found to have a defect in the load-bearing portion of the tiedown as outlined in the “Tiedown Defect Table” will not be considered when determining the weight and/or length requirements.

Individual tiedowns being used to secure cargo found in conditions outlined in the table are not out of service, only violations. If these tiedowns are required to meet the requirements for length and/or weight, the out-of-service condition(s) will be recorded under the applicable weight and/or length and/or the specific commodity. (393.104)

***Operational Policy 15 – Inspection/Regulatory Guidance: Regulatory Guidance 2.b.(2) – Violation Guidance for Damaged Tiedowns***

***\*Inspection Bulletin – 2018-03 Doleco USA Textile Link Tiedown Assembly***

**\*TIEDOWN DEFECT TABLE**

Chain

- Loose chain.
- Contains nicks, gouges, abrasions, or broken, cracked, twisted, bent, knotted or stretched links.

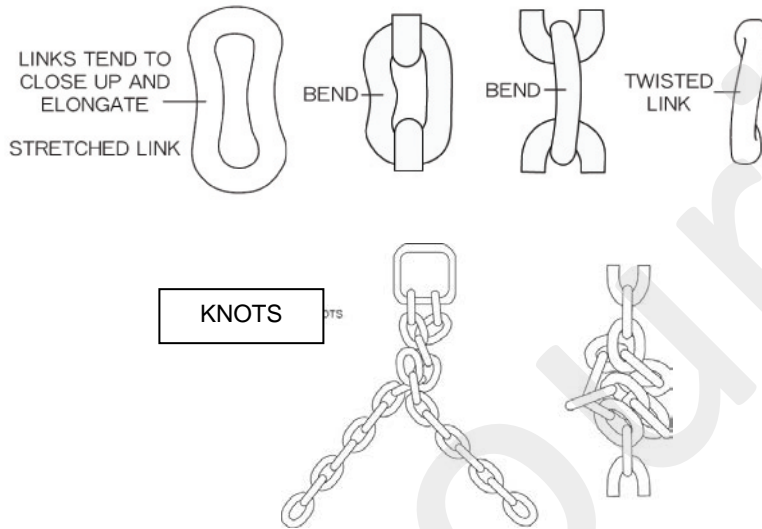

- Excessive wear causing a 20 percent or more reduction in original material thickness.

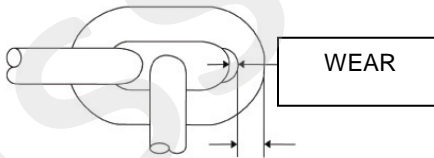

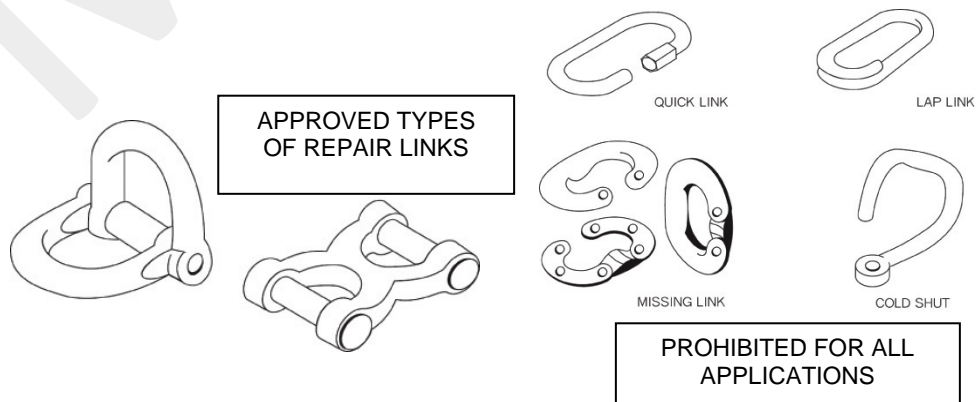

- Any weld(s) on chain, to repair broken/damaged links or to join links.

**NOTE:** Repairs. Links of the clevis variety, having strength equal to or greater than the nominal chain are acceptable.



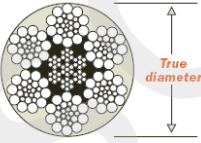

- Chain is damaged as a result of missing edge protection.

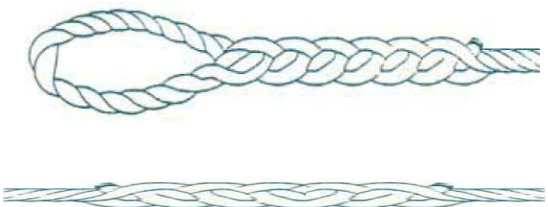
### TIEDOWN DEFECT TABLE

Wire Rope	<ul style="list-style-type: none"> <li>Loose wire rope.</li> <li>Kinks, bird caging, popped core or knots in the working section of the wire rope.</li> </ul>
	
	<ul style="list-style-type: none"> <li>Discoloration from excessive heat or electric arc in the eye or main body of the wire rope.</li> </ul>
	<ul style="list-style-type: none"> <li>Corrosion with pitting of the external or internal wires.</li> </ul>
	<ul style="list-style-type: none"> <li>More than 11 broken wires in 6 diameters of length. For example: with 1/2 inch (12.7 mm) wire rope, more than 11 broken wires in (6 x 1/2) or 3 inches in length (6 x 13 = 78 mm).</li> </ul>
	
	<ul style="list-style-type: none"> <li>More than three broken wires in any one strand.</li> </ul>
	
	<ul style="list-style-type: none"> <li>More than two broken wires at the end connection or fitting.</li> </ul> <p><b>NOTE:</b> Repairs. Wire rope used in tiedown assemblies shall not be repaired or spliced. (Eye splices and back splices are acceptable.)</p>
	 <div style="display: flex; justify-content: space-around; margin-top: 10px;"> <div style="border: 1px solid black; padding: 5px; text-align: center;">EYE SPLICE</div> <div style="border: 1px solid black; padding: 5px; text-align: center;">BACK SPLICE</div> </div>
	<ul style="list-style-type: none"> <li>Wire rope is damaged as a result of missing edge protection.</li> </ul>

### TIEDOWN DEFECT TABLE

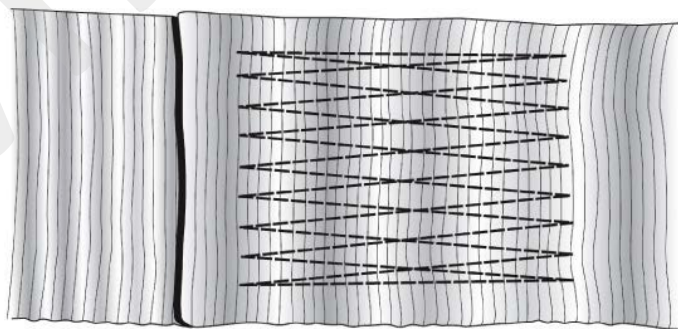
<p>Cordage (Fiber Rope)</p>	<ul style="list-style-type: none"> <li>● Loose cordage (fiber rope).</li> <li>● Burned or melted fibers except on heat-sealed ends.</li> <li>● Ineffective knots formed for the purpose of connecting or repairing binders.</li> <li>● ** Evidence of excessive wear in exterior or interior fibers.</li> <li>● ** Any evidence of loss of strength, such as a marked reduction in diameter.</li> </ul> <p><b>** NOTE:</b> Effective diameter of cordage reduced by 20 percent is excessive. Repairs: Cordage used in tiedown assemblies shall not be repaired. (Separate lengths of cordage properly spliced together are not considered repairs.)</p> <div style="display: flex; justify-content: space-around; align-items: center;"> <div style="text-align: center;">  </div> <div style="border: 1px solid black; padding: 5px; text-align: center;"> <p>CHAFED AND FRAYED YARNS</p> </div> </div> <div style="display: flex; justify-content: space-around; align-items: center; margin-top: 20px;"> <div style="text-align: center;">  </div> <div style="border: 1px solid black; padding: 5px; text-align: center;"> <p>MINOR ABRASION OK TO CONTINUE USE</p> </div> </div>
	<ul style="list-style-type: none"> <li>● Cordage (fiber rope) is damaged as a result of missing edge protection.</li> </ul>
<p>Synthetic Webbing</p>	<ul style="list-style-type: none"> <li>● Loose synthetic webbing.</li> <li>● The tiedown contains separation of its load carrying stitch pattern(s) in excess of 1/4 of the total stitch area.</li> </ul> <p style="text-align: center;">Graphic of example of a load-bearing stitch pattern at hook end.</p> <div style="text-align: center; margin: 10px 0;">  </div> <ul style="list-style-type: none"> <li>● A fitting, tensioning device or other hardware (other than the webbing) is broken, obviously sprung, bent, twisted, or contains a visible crack or a significant nick or gouge.</li> <li>● The tiedown contains a knot, repair, splice or any other apparent defect (e.g., crushed areas, damaged loop ends, severe abrasions, etc.).</li> </ul>

### TIEDOWN DEFECT TABLE

Synthetic Webbing

- The tiedown contains cut(s), burn(s) and/or hole(s) through the webbing which total more than that shown in the Defect Classification Table.

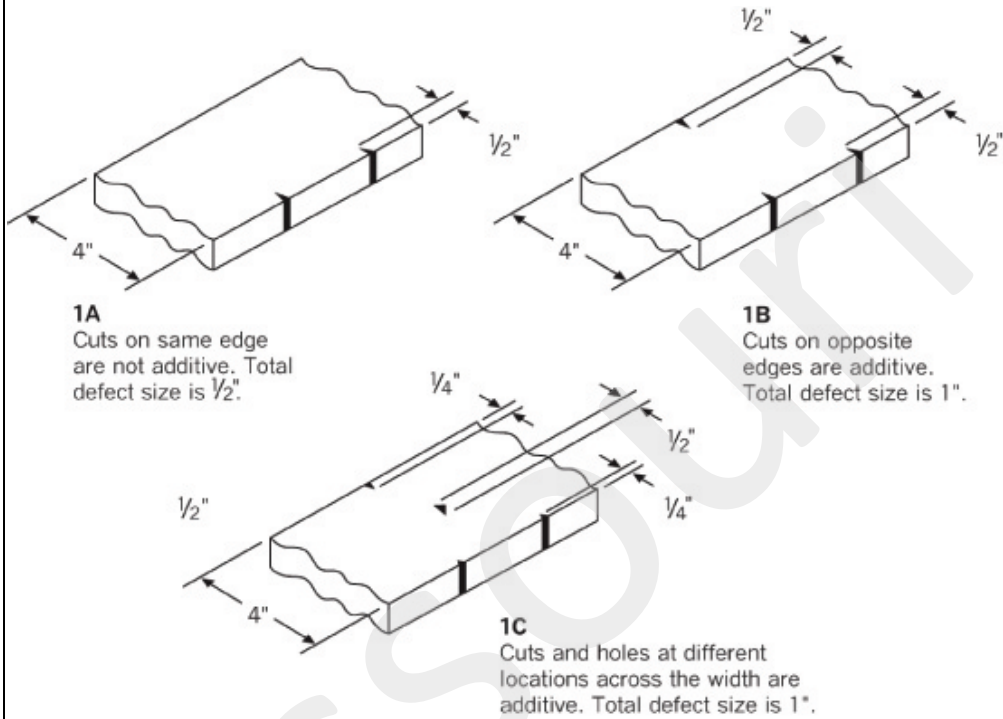

#### DEFECT CLASSIFICATION TABLE

Total Defect Size

<u>Web Size</u> Inches (mm)	<u>Defect Range</u> Inches (mm)
4 (100)	Larger than $\frac{3}{4}$ (19)
3 (75)	Larger than $\frac{5}{8}$ (16)
2 (50)	Larger than $\frac{3}{8}$ (10)
1 $\frac{3}{4}$ (45)	Larger than $\frac{3}{8}$ (10)

All cut(s), burn(s) and/or hole(s) through the webbing are additive across the width of the strap face for its entire effective length. But only one defect is additive for any specific width.

**NOTE:** Repairs. Webbing used in tiedown assemblies shall not be repaired or spliced.

- Synthetic webbing is damaged as a result of missing edge protection.

**\*TIEDOWN DEFECT TABLE**

\* Doleco USA  
Textile Link  
Tiedown  
Assembly

- Tiedowns shall not be loose.
- Tiedowns must not be knotted.
- A fitting, tensioning device or other hardware (other than webbing) shall not be broken, obviously sprung, bent, twisted, or contain a visible crack, significant nick or gouge.
- Tensioning and connecting elements must not be loaded to the point of bending.
- Links shall not be deformed due to heat (friction, radiation).
- Lashing hooks must be loaded in the hook bowl (see lashing hook with the adapted clevis hook mount). Links may not be loaded on the hook tip.
- The hook mouth must not be widened by 5 percent or more.
- Links shall not contain cut layers and severe abrasions.



- Links shall not have more than one 10 percent transverse or longitudinal cut.

TRANSVERSE

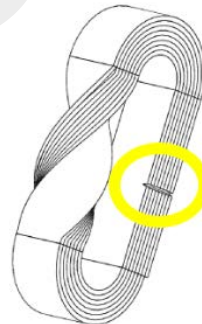

LONGITUDINAL



- Links shall not have one ply (or more) cut through – inside or outside.

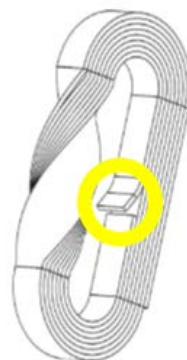



### TIEDOWN DEFECT TABLE

Doleco USA  
Textile Link  
Tiedown  
Assembly

- Links must have yarn completely through the stitching; not partly cut through.

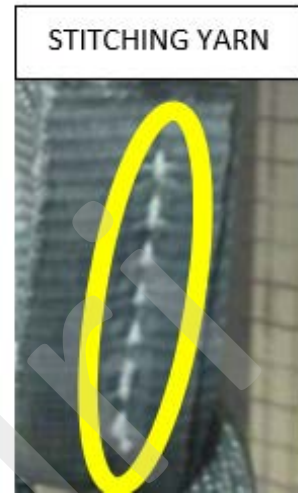

- The hook is not hooked in between the plies.



- Links shall not contain repairs to damaged ply.
- The unscrewing safeguard of the load binder must not be disabled or damaged.

The special load tensioner is equipped with an unscrewing safeguard.

The unscrewing safeguard of this tensioner consists of a bolt at the end of the spindle arm that stops against the internal thread of the guide tube as soon as the maximum unscrewing length has been reached. Overturning of this safeguard is possible only with the use of extreme force and is noticeable in all cases. If the safeguard is overturned, the bolt cuts into the internal thread of the guide tube and destroys it.

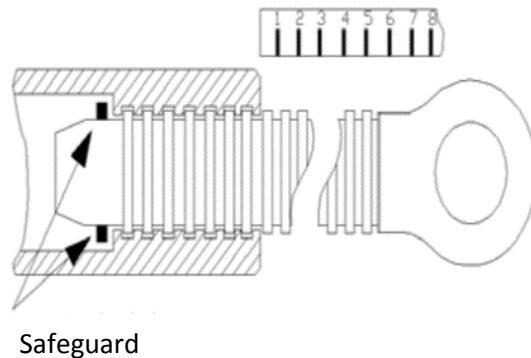

<b>TIEDOWN DEFECT TABLE</b>	
Steel Strapping	<ul style="list-style-type: none"> <li>• Loose steel strapping.</li> </ul>
	<ul style="list-style-type: none"> <li>• Steel strappings more than 1 inch (25.4 mm) in width not having at least two pair of crimps in each seal.</li> </ul>
	<ul style="list-style-type: none"> <li>• Steel strappings arranged in an end-over-end lap joint not sealed with at least two seals.</li> </ul>
	<ul style="list-style-type: none"> <li>• Obviously damaged or distorted steel strappings.</li> </ul>
	<ul style="list-style-type: none"> <li>• Steel strapping is damaged as a result of missing edge protection.</li> </ul>
Fitting / Attachment / Tensioning Device	<ul style="list-style-type: none"> <li>• Obvious reduction of section through wear or corrosion.</li> </ul>
	<ul style="list-style-type: none"> <li>• Obviously distorted or stretched load binders and fittings.</li> </ul>
	<ul style="list-style-type: none"> <li>• Hooks opened in the throat beyond the original parallel throat opening.</li> </ul>
	<ul style="list-style-type: none"> <li>• Any missing required component.</li> </ul>
	<ul style="list-style-type: none"> <li>• Obvious twisting out of the plane of the fitting.</li> </ul>
	<ul style="list-style-type: none"> <li>• A fitting, tensioning device, or other hardware is broken, obviously sprung, bent, twisted, or contains a visible crack or a significant nick or gouge.</li> </ul>
	<ul style="list-style-type: none"> <li>• Welding or discoloration from excessive heat.</li> </ul> <p><b>NOTE:</b> Some winches are designed to be welded to the truck bed.</p>
	<ul style="list-style-type: none"> <li>• Any visible cracks.</li> </ul>
	<ul style="list-style-type: none"> <li>• Any slippage detectable at a wire rope "cable clamp."</li> </ul> <p><b>NOTE:</b> End fittings may be replaced with clevis type.</p>
	<ul style="list-style-type: none"> <li>• Any slippage detectable at a wire rope "cable clamp."</li> </ul> <p><b>NOTE:</b> End fittings may be replaced with clevis type.</p>
Anchor Point	<ul style="list-style-type: none"> <li>• Broken or cracked side or pocket rails, supports, or welds.</li> </ul>
	<ul style="list-style-type: none"> <li>• Rails bent or distorted where hooks or fittings attach.</li> </ul>
	<ul style="list-style-type: none"> <li>• Floor rings nicked, gouged, worn, twisted, bent, stretched or with broken welds.</li> </ul>



### 3. COUPLING DEVICES

**NOTE:** The following criterion only applies when the device is in use.

**NOTE:** "Parent Metal" is the part (angle iron, pivot bracket, mounting plate, slider base plate, fifth wheel plate, upper coupler). "Non-Parent Metal" is weld material.

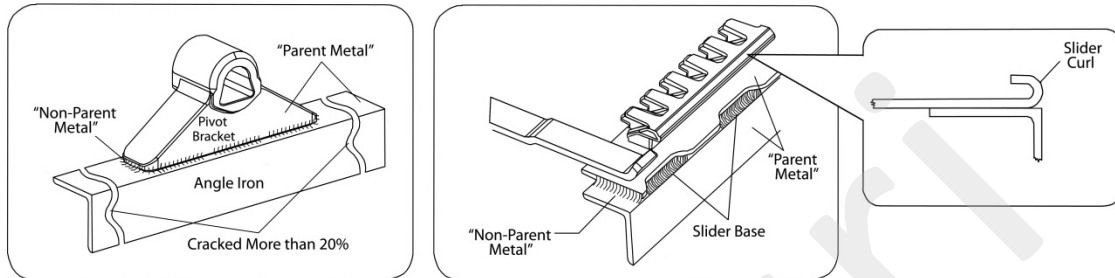

#### a. Fifth Wheels (Lower Coupler Assembly)

##### (1) Mounting to Frame

- (a) More than 20 percent of fasteners on either side of the vehicle are missing or ineffective. (393.70(b)(1)(i))
- (b) Any movement between mounting components. (393.70(b)(1)(i))
- (c) A crack in the mounting angle iron (parent metal) extending more than 20 percent of the distance across the metal in the direction of the crack. (393.70(b)(1)(i))
- (d) A crack, or a gap caused by corrosion, that is 1/8 inch (3.2 mm) or more in width. (393.70(b)(1)(i))
- (e) More than 20 percent of the total length of all the original welds (including fore and aft welds) are cracked on either side of the vehicle. (393.70(b)(1)(i))
- (f) A repair weld is cracked. (393.70(b)(1)(i))

##### (2) Mounting Plates and Pivot Brackets

- (a) More than 20 percent of fasteners on either side of the vehicle are missing or ineffective. (393.70(b)(1)(i))
- (b) A crack in the mounting plate or pivot bracket (parent metal) extending more than 20 percent of the distance across the metal in the direction of the crack. (393.70(b)(1)(i))

- (c) A crack, or a gap caused by corrosion, that is 1/8 inch (3.2 mm) or more in width. (393.70(b)(1)(i))
- (d) More than 20 percent of the total length of all the original welds (including fore and aft welds) are cracked on either side of the vehicle. (393.70(b)(1)(i))
- (e) A repair weld is cracked. (393.70(b)(1)(i))
- (f) More than 3/8 inch (9.5 mm) horizontal movement between pivot bracket pin and bracket. (393.70(b)(1)(i))
- (g) Pivot bracket pin missing or not secured. (393.70(b)(1)(i))

(3) Sliders

- (a) More than 25 percent of latching fasteners on either side of the vehicle are ineffective. (393.70(b)(1)(i))
- (b) Any fore or aft stop missing or not securely attached. (393.70(b)(1)(i))

**NOTE:** A moveable fifth wheel that is secured with vertical pins does not need fore or aft stops.

- (c) Movement of more than 3/8 inch (9.5 mm) between slide bracket and slide base. (393.70(b)(1)(i))
- (d) A slide curl is broken, cracked or repaired by welding. (393.70(b)(1)(i))

(4) Operating Handle

Operating handle not in closed or locked position. (393.70(b)(2))

(5) Fifth Wheel Plate

- (a) A crack in the fifth wheel plate (parent metal) extending more than 20 percent of the distance across the metal in the direction of the crack. (396.3(a)(1))
- (b) A crack, or a gap caused by corrosion, that is 1/8 inch (3.2 mm) or more in width. (396.3(a)(1))
- (c) A repair weld is cracked. (396.3(a)(1))

**EXCEPTIONS:** (1) Cracks in fifth wheel approach ramps, and (2) casting shrinkage cracks in the ribs of the body of a cast fifth wheel.

(6) Locking Mechanism

Locking mechanism parts missing, broken or deformed to the extent that the kingpin is not securely held. (393.70(b)(2))

b. Upper Coupler Assembly (Including Kingpin)

- (1) Horizontal movement between the upper and lower fifth wheel halves exceeds 1/2 inch (12.7 mm). (396.3(a)(1))

**Operational Policy 15 – Inspection/Regulatory Guidance: Regulatory Guidance 3.b.(1) – Fifth Wheel Play**

- (2) Kingpin can be moved by hand in any direction. (396.3(a)(1))

**NOTE:** This item is to be used when uncoupled semitrailers are encountered, such as at a terminal inspection, and it is impossible to check item (1) above. Kingpins in coupled vehicles are to be inspected using item (1) above and items (3) and (4) below. Vehicles are not to be uncoupled.

- (3) Kingpin not properly engaged. (393.70(b)(2))

- (4) Any trailer with a bolted upper coupler, which has fewer effective bolts than shown below. (393.70(b)(1)(i))

**NOTE:** This only applies to hex head bolts and should not be applied to flat countersunk socket head cap screws. (ASTM F835)



- (5) A crack in the upper coupler (parent metal) extending more than 20 percent of the distance across the metal in the direction of the crack. (393.70(b)(1)(i))

- (6) A crack, or a gap caused by corrosion, that is 1/8 inch (3.2 mm) or more in width. (393.70(b)(1)(i))

- (7) More than 20 percent of the total length of all the original welds are cracked on either side, front or back of the upper coupler. (393.70(b)(1)(i))









- (8) A repair weld cracked. (393.70(b)(1)(i))

Minimum Number of Bolts per Side Based on Type & Size** of Bolt						
Maximum Trailer GVWR	ASTM A325 Type 1, 2 and 3 (Metric 5.8)		SAE J429 Grade 5 (Metric 8.8)		SAE J429 Grade 8 (Metric 10.9)	
	1/2" (12 mm)	5/8" (16 mm) or larger	1/2" (12 mm)	5/8" (16 mm) or larger	1/2" (12 mm)	5/8" (16 mm) or larger
68,000 lbs. (30,844 kg) or less	6	4	6	4	5	4
68,001 - 85,000 lbs.(30,845 - 38,555 kg)	8	5	8	5	7	5
85,001 - 105,000 lbs. (38,556 - 47,627 kg)	10	6	10	6	8	5

\*\* Bolt size refers to the outside diameter of the thread.

- 1/2 inch bolts have 3/4 inch heads and nuts
- 5/8 inch bolts have 15/16 inch heads and nuts
- 12 mm bolts have 19 mm heads and nuts
- 16 mm bolts have 24 mm heads and nuts

#### BOLT HEAD GRADE IDENTIFICATION MARKING

ASTM A325 Type 1	ASTM A325 Type 2	ASTM A325 Type 3	SAE J429 Grade 5	SAE J429 Grade 8	Metric 5.8	Metric 8.8	Metric 10.9
							

c. Pintle Hooks

Mounting and Integrity

- (1) Loose mounting, missing or ineffective fasteners, or insecure latch. (Trailer - 393.70(c) or Driveaway - 393.71(h))

**NOTE:** A fastener is not considered missing if there is an empty hole in the device but no corresponding hole in the frame and vice versa.

- (2) Cracks anywhere in the pintle hook assembly including mounting surface and frame cross member. (Trailer - 393.70(c) or Driveaway - 393.71(h))
- (3) Any welded repairs to the pintle hook assembly. (Trailer - 393.70(c) or Driveaway - 393.71(h))
- (4) Section reduction visible when coupled. (Trailer - 393.70(c) or Driveaway - 393.71(h))

**NOTE:** No part of the horn should have any section reduced by more than 20 percent. If wear can be seen when the hook and eye are coupled, it is possible that either this condition or section reduction in the draw bar eye exists.

***Operational Policy 15 – Inspection/Regulatory Guidance: Regulatory Guidance 3.b.(2) – Pintle Hook Violations***

d. Drawbar Eye

Mounting and Integrity

- (1) Any cracks in attachment welds or drawbar eye. (Trailer - 393.70(c) or Driveaway - 393.71(h))
- (2) Any missing or ineffective fasteners. (Trailer - 393.70(c) or Driveaway - 393.71(h))
- (3) Any welded repairs to the drawbar eye. (Trailer - 393.70(c) or Driveaway - 393.71(h))
- (4) Section reduction visible when coupled. (Trailer - 393.70(c) or Driveaway - 393.71(h))

**NOTE:** No part of the eye should have any section reduced by more than 20 percent. If wear can be seen when the hook and eye are coupled, it is possible that either this condition or section reduction in the pintle hook exists.

e. Drawbar/Tongue

- (1) Slider (Power/Manual)
  - (a) Ineffective latching mechanism. (Trailer - 393.70(c) or Driveaway - 393.71(h))
  - (b) Missing or ineffective stop. (Trailer - 393.70(c) or Driveaway - 393.71(h))
  - (c) Movement of more than 1/4 inch (6.4 mm) between the slider and housing. (Trailer - 393.70(c) or Driveaway - 393.71(h))
  - (d) Any leaking air or hydraulic cylinders, hoses or chambers (other than slight oil weeping normal with hydraulic seals). (Trailer 393.70(c) or Driveaway - 393.71(h))
- (2) Integrity
  - (a) Any cracks. (Trailer - 393.70(c) or Driveaway - 393.71(h))
  - (b) Movement of 1/4 inch (6.4 mm) between sub frame and drawbar at point of attachment. (Trailer - 393.70(c) or Driveaway - 393.71(h))

f. Safety Devices

- (1) Missing. (Trailer - 393.70(d) or Driveaway - 393.71(h)(10))
- (2) Unattached or incapable of secure attachment. (Trailer - 393.70(d) or Driveaway - 393.71(h)(10))
- (3) Improper repairs to chains and hooks including welding, wire, small bolts, rope and tape. (Trailer - 393.70(d) or Driveaway - 393.71(h)(10))
- (4) Chain or Wire Rope: Damaged or defective to the same extent as the criterion used for chain or wire rope defects described in the "Cargo Securement – Tiedown Defect Table." (Trailer - 393.70(d) or Driveaway - 393.71(h)(10))

**EXCEPTION:** Quick-link(s) that are fully engaged, and marked with a manufacturer's minimum breaking strength/force (MBS/MBF) rating on the link that is equal to or greater than the GVW of the trailer(s), are acceptable for use in a safety device.

**EXCEPTION:** A chain that has been twisted or knotted to account for excess slack in the safety device is not considered to be defective.

g. Hitch Systems (Excluding Fifth Wheels and Pintle Hooks)

Mounting and Integrity

- (1) Loose mounting, missing or ineffective fasteners, or insecure latch. (Trailer - 393.70(c) or Driveaway - 393.71(h))

**NOTE:** A fastener is not considered missing if there is an empty hole in the device but no corresponding hole in the frame and vice versa.

- (2) Cracks anywhere in the hitch system including mounting surface and frame cross member. (Trailer - 393.70(c) or Driveaway - 393.71(h))
- (3) Any welded repairs to the ball, ball-socket, pin or eye. (Trailer - 393.70(c) or Driveaway - 393.71(h))

h. Saddle-Mounts (Method of Attachment)

- (1) Any missing or ineffective fasteners. (Upper - 393.71(j) or Lower - 393.71(k))
- (2) Loose mountings. (Upper - 393.71(j) or Lower - 393.71(k))
- (3) Any cracks or breaks in a stress or load-bearing member. (Upper - 393.71(j) or Lower - 393.71(k))
- (4) Horizontal movement between upper and lower saddle-mount halves exceeds 1/4 inch (6.4 mm). (Upper - 393.71(j) or Lower - 393.71(k))

i. Full Trailer (Double Ring, Ball-Bearing Turntable)

- (1) Mounting – Top and Bottom
- (a) Top flange has less than 6 effective bolts. (393.70(c))
- (b) Bottom flange has less than 6 effective bolts. (393.70(c))
- (c) 20 percent or more of original welds (or repaired original welds) or parent metal cracked. (393.70(c))
- (2) Wear
- (a) Upper flange half touching lower flange half. (393.70(c))
- (b) Cracked flanges. (393.70(c))

**\*4. DRIVELINE/DRIVESHAFT**

a. Yoke Ends (Including Slip Yoke, Yoke Shaft, Tube Yoke and End Fitting Yoke)

- (1) Any visible crack in a yoke end. (396.3(a)(1))
- (2) Any yoke-mounting hardware loose (with hand pressure only), broken or missing. (396.3(a)(1))
- (3) Any horizontal or vertical movement of slip joint yoke shaft of greater than 1/2 inch (12.7 mm), with hand pressure only. (396.3(a)(1))
- (4) Any loose, broken or missing end fitting fastener. (Also see item 4.b.(1)) (396.3(a)(1))

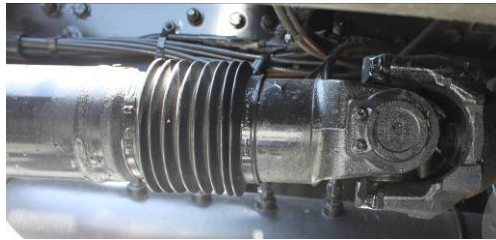

Slip Joint

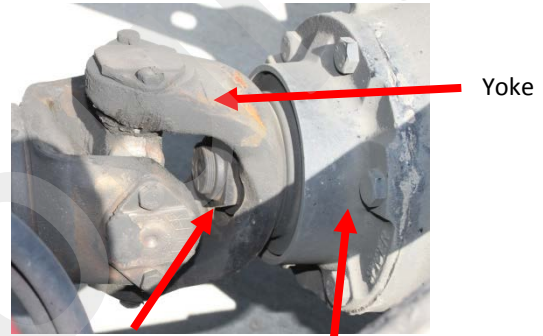

Yoke Nut  
(Mounting Hardware)

End Fitting

\*b. Universal Joint

- (1) Any independent vertical movement between opposing yoke ends greater than 1/8 inch (3.2 mm), with hand pressure only. (396.3(a)(1))
- (2) Any missing universal joint bearing cap. (Also see item 4.b.(1)) (396.3(a)(1))
- \* (3) Any missing, broken or loose universal joint bearing cap bolt, bearing strap or retainer bolt. (396.3(a)(1))
- (4) Any bearing cap retainer clip is missing. (396.3(a)(1))

Bearing Cap Retainer Clip



Bearing Assembly Cap

Bearing Cap Bolt

Retainer Bolt

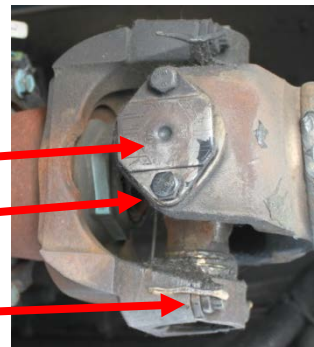



c. Center Bearing (Carrier Bearing)

- (1) Any broken or loose center bearing bracket, bracket bolts or mounting hardware. (396.3(a)(1))
- (2) Any center bearing bracket crack equaling 50 percent or more of the original bracket width. (396.3(a)(1))
- (3) More than 1/2 inch (12.7 mm) vertical movement (with hand pressure only) of the shaft in the center bearing carrier. (396.3(a)(1))

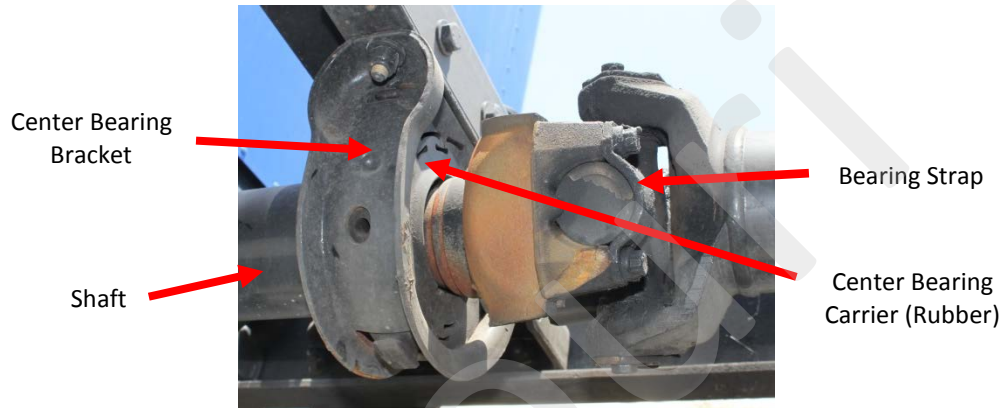

d. Driveshaft Tube

- (1) Any original metal crack in the shaft tube greater than 1/4 inch (6.4 mm) in length. (396.3(a)(1))
- (2) Obvious cracked weld at shaft tube end. (396.3(a)(1))
- (3) Any shaft tube with obvious twist. (396.3(a)(1))

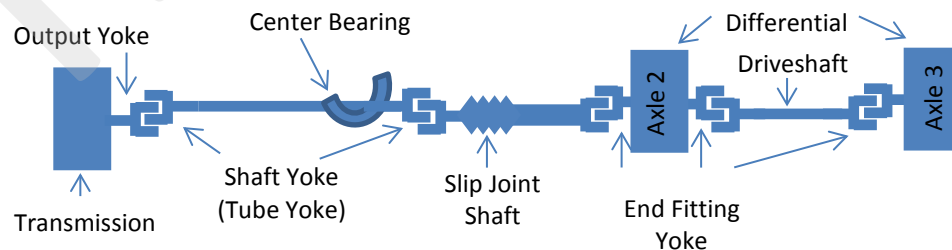

***Inspection Bulletin 2014-01 – Driveline/Driveshaft Inspections***

***Operational Policy 15 – Inspection/Regulatory Guidance: Regulatory Guidance 4.b.(1) – Driveline/Driveshaft Violations***

**\*5. DRIVER'S SEAT (MISSING)**

**\*a. Temporary Seating**

Any vehicle that has temporary seating for the driver.

**NOTE:** Temporary seating includes the use of items not designed for use as seats in vehicles, including but not limited to a milk crate, lawn chair, patio chair, folding chair, plastic step, stool or a cooler. (393.93(b))

**\*6. EXHAUST SYSTEMS**

**\*a. Leaks – All Commercial Motor Vehicles**

Any exhaust system leaking at a point forward of or directly below the driver/sleeper compartment and the vehicle has a condition that permits entry of exhaust fumes into the driver/sleeper compartment. (393.83(g))

**\*b. Gasoline-Powered Buses**

Any gasoline-powered bus exhaust system that is leaking or discharging under the chassis more than 6 inches (15.24 cm) forward of the rear most part of the bus. (393.83(c))

**\*c. Buses Powered by Other Than Gasoline**

Any bus, powered by other than gasoline engine, exhaust system that is leaking or discharging under the chassis more than 15 inches (38.1 cm) forward of the rear most part of the bus, unless the exhaust is leaking or discharging to the rear of all doors or windows designed to be opened, except for those windows or doors designed solely as emergency exits. (393.83(d))

**\*d. Location of Exhaust**

No part of the exhaust system of any commercial motor vehicle shall be so located as to be likely to result in burning, charring, or damaging the electrical wiring, the fuel supply, or any combustible part of the commercial motor vehicle. (393.83(a))

***Inspection Bulletin 2010-02 – Inspection of Vehicles Equipped with 2007 or Later EPA-Certified Engines***

**\*7. FRAMES**

**\*a. Frame Members**

(1) Any cracked, loose, sagging or broken frame siderail permitting shifting of the body onto moving parts or other condition indicating an imminent collapse of the frame. (393.201(a))

- (2) Any cracked, loose, or broken frame member adversely affecting support of functional components such as steering gear, fifth wheel, engine, transmission, body parts and suspension. (393.201(a))
- (3) 1 1/2 inch (38 mm) or longer crack in frame siderail web which is directed toward bottom flange. (393.201(a))
- (4) Any crack extending from the frame siderail web around the radius and into the bottom flange. (393.201(a))
- (5) 1 inch (25.4 mm) or longer crack in siderail bottom flange. (393.201(a))

**\*NOTE:** Items (1) and (2) apply to all buses, including those having unitized (monocoque) construction. Items (3), (4) and (5) apply only to buses having a body-on-chassis design, such as most school buses.

***\*Inspection Bulletin 2018-02 – Motorcoach Monocoque Frame-Suspension Inspections***

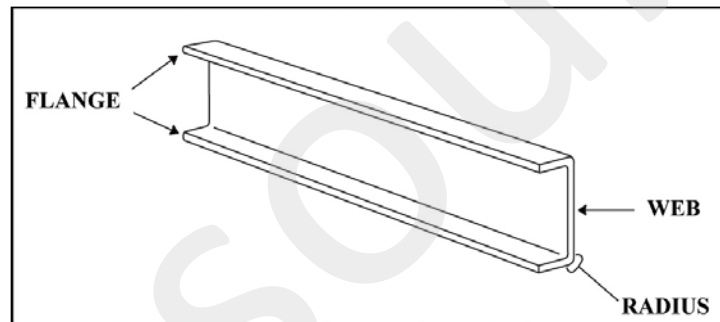

b. Tire and Wheel Clearance

Any condition, including loading, that causes the body or frame to be in contact with a tire or any part of the wheel assemblies at the time of inspection. (396.3(a)(1))

**\*8. FUEL SYSTEMS**

a. Liquid Fuels

- (1) A fuel system with a dripping leak at any point (including refrigeration or heater fuel systems). (396.3(a)(1))
- (2) A fuel tank not securely attached to the vehicle. (393.65(c))

**NOTE:** Some fuel tanks use spring or rubber bushings to permit movement.

- (3) Passenger-Carrying Vehicle: Missing fuel cap. (393.67(c)(7)(v))

b. Gaseous Fuels

Compressed Natural Gas (CNG), Liquefied Petroleum Gas (LPG) and Liquefied Natural Gas (LNG)

**OCCUPATIONAL SAFETY NOTE:** Personnel must exercise extreme caution whenever checking a gaseous fuel system for leaks. Any possibility of creating sparks, static electricity, friction, etc. must be avoided, as they could cause a fire or explosion.

**OCCUPATIONAL SAFETY NOTE:** Vehicles with leaking gaseous fuel systems must be parked carefully. Gases escaping from CNG and LNG systems will rise. If the vehicle is parked inside a building or under a canopy, roof or similar cover, combustible gasses can collect beneath the ceiling. Escaping LPG falls and can form a “pool” of combustible gas near the ground and displaces air including oxygen. LPG and liquid LNG will flow into open drains. Combustible gases can explode when ignited by an open flame or spark.

(1) CNG or LPG

Any fuel leakage from the CNG or LPG system detected visibly, audibly or by smell and verified by either a bubble test using non-ammonia, non-corrosive soap solution or a reading of more than 5,000 PPM on a flammable gas detection meter. (396.3(a)(1))

**NOTE:** Verification is needed to ensure that the sound is not either internal to the fuel system (such as gas flowing in a pressure regulator or pressure equalizing between manifolded tanks) or a leak in the air brake system.

**NOTE:** Some brief fuel leakage or decompression may occur during refueling, causing temporary frosting of CNG or LPG fuel system parts. If the vehicle has been refueled shortly before inspection, care must be taken to distinguish these temporary frosting occurrences from actual leaks.

(2) LNG

**OCCUPATIONAL SAFETY NOTE:** LNG is a cryogenic material and presents a potential safety hazard due both to the extremely cold temperature of its liquid and the flammability of its vapor. Personnel inspecting such systems should exercise utmost caution including the wearing of proper eye protection, gloves and clothing.

**NOTE:** LNG liquid and vaporized gas is odorless and undetectable by the human sense of smell. Frost buildup is not necessarily evidence of leakage. Many components of LNG fuel systems are extremely cold and will exhibit an even coat of frost produced by moisture in the surrounding air condensing and freezing on them.

(a) A cloud of water vapor coming from any component of the fuel system. (396.3(a)(1))

**NOTE:** It is normal, particularly in humid conditions, for water vapor to collect around many portions of a LNG fuel system.

- (b) Any fuel leakage from the LNG system detected visibly or audibly and verified by either a bubble test using non-ammonia, non-corrosive soap solution or a reading of more than 5,000 PPM on a flammable gas detection meter. (396.3(a)(1))
- (c) Dripping liquid that boils or vaporizes in the air. (396.3(a)(1))

**\*9. LIGHTING DEVICES (HEADLAMPS, TAIL LAMPS, STOP LAMPS, TURN SIGNALS AND LAMPS/FLAGS ON PROJECTING LOADS)**

a. When Lights Are Required

- (1) Headlamps - The single vehicle or towing vehicle does not have at least one head lamp operative on low beam. (Inoperative - 393.9(a); Obscured - 393.9(b); Missing - 393.11(a)(1); or, Driveaway - 393.17(a)(1))
- (2) Lamps on rear - Bus, truck, truck tractor, and towed vehicle (including driveaway/towaway operations) not having at least one steady burning tail lamp on the rear of the rearmost vehicle visible from 500 feet (152.4 m). (Inoperative - 393.9(a); Obscured - 393.9(b); Missing - 393.11(a)(1); or, Driveaway - 393.17(b)(2))
- (3) Lamps on projecting loads - There is not at least one operative steady burning lamp on the rear of loads projecting more than 4 feet (1.2 m) beyond the vehicle body, visible from 500 feet (152.4 m). (Inoperative - 393.9(a); Obscured - 393.9(b); or, Missing - 393.11(a)(1))

b. At Anytime – Day or Night

- (1) Does not have at least one operative stop lamp on the rear of a single unit vehicle or the rear of the rearmost vehicle of a combination of vehicles visible at 500 feet (152.4 m). (Inoperative - 393.9(a); Obscured - 393.9(b); Missing - 393.11(a)(1); or, Driveaway - 393.17(b)(2))
- (2) Does not have an operative turn signal visible on each side of the rear of a single unit vehicle or the rear of the rearmost vehicle of a combination of vehicles. (Inoperative - 393.9(a); Obscured - 393.9(b); Missing - 393.11(a)(1); or, Driveaway - 393.17(b)(2))

**EXCEPTION:** A truck tractor operated as a single unit is not in an out-of-service condition for an inoperative rear turn signal when the turn signals located on the front are visible from the rear.

- (3) Does not have at least one required flag on the rear of loads projecting more than 4 feet (1.2 m) beyond the vehicle body. (393.87(a))
- (4) All electrical systems on towed vehicle(s) inoperative due to no electrical connection (i.e., unplugged or loose pigtail). (393.23)

**NOTE:** After electrical connection is re-established, all towed vehicle(s) electrical systems shall be inspected and, if applicable, recorded as per Operational Policy 14.

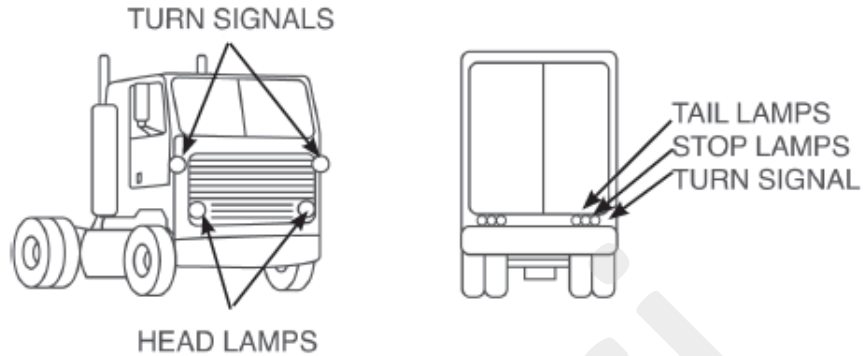

**Operational Policy 15 – Inspection/Regulatory Guidance: Regulatory Guidance 8.b.(1) – Clearance Light Violations**

**Operational Policy 15 – Inspection/Regulatory Guidance: Regulatory Guidance 8.b.(2) – Converter Dolly Lighting**

**Operational Policy 15 – Inspection/Regulatory Guidance: Regulatory Guidance 8.b.(3) – Retro-Reflective Sheeting**

**\*10. STEERING MECHANISMS**

a. Steering Wheel Lash (Free Play)

(See Chart: When any of these values - inch movement or degrees - are met or exceeded, vehicle shall be declared out of service.) (393.209(b))

For power steering systems, engine must be running.

<u>Steering Wheel Diameter</u>	<u>Manual System Movement 30°</u>	<u>Power System Movement 45°</u>
16" (40.6 cm)	4 1/2" (11.4 cm)(or more)	6 3/4" (17.1 cm)(or more)
18" (45.7 cm)	4 3/4" (12 cm)(or more)	7 1/8" (18.1 cm)(or more)
19" (48.2 cm)	5" (12.7 cm)(or more)	7 1/2" (19 cm)(or more)
20" (50.8 cm)	5 1/4" (13.3 cm)(or more)	7 7/8" (20 cm)(or more)
21" (53.3 cm)	5 1/2" (13.9 cm)(or more)	8 1/4" (20.9 cm)(or more)
22" (55.8 cm)	5 3/4" (14.6 cm)(or more)	8 5/8" (21.9 cm)(or more)

For power systems, if steering wheel movement exceeds 45 degrees before steering axle tires move, proceed as follows: Rock steering wheel left to right between points of power steering valve resistance. If that motion exceeds 30 degrees (or the inch movement values shown for manual steering), vehicle shall be declared out of service. This test is to differentiate between excessive lash and power systems designed to avoid providing steering assistance when the steering wheel is turned while the truck is motionless (not moving forward or backward).

b. Steering Column

- (1) Any absence or looseness of u-bolt(s) or positioning part(s). (393.209(c))
- (2) Obviously repair-welded universal joint(s). (393.209(d))
- (3) Steering wheel not properly secured. (393.209(a))
- (4) Telescopic steering column does not lock into position. (396.3(a)(1))
- (5) Tilt steering column does not lock in at least one position. (396.3(a)(1))

c. Front Axle Beam and All Steering Components other than Steering Column (Including Hub)

- (1) Any crack(s). (396.3(a)(1))
- (2) Any obvious welded repair(s). (396.3(a)(1))

d. Steering Gear Box (Including Rack and Pinion)

- (1) Any mounting bolt(s) loose or missing. (393.209(d))
- (2) Any crack(s) in gear box or mounting brackets. (393.209(d))
- (3) Any obvious welded repair(s). (396.3(a)(1))
- (4) Any looseness of the yoke-coupling to the steering gear input shaft. (393.209(d))

***Inspection Bulletin 2010-03 – Rack and Pinion Steering System Inspection***

e. Pitman Arm

- (1) Any looseness of the pitman arm on the steering gear output shaft. (393.209(d))
- (2) Any obvious welded repair(s). (396.3(a)(1))

f. Power Steering

Auxiliary power assist cylinder separated at either end from the attachment point(s) allowing movement of more than 1 inch (25.4 mm) in any direction. (393.209(e))

g. Ball and Socket Joints

- (1) Any movement under steering load of a stud nut. (393.209(d))
- (2) Any motion, other than rotational, between any linkage member and its attachment point of more than 1/8 inch (3.2 mm) measured with hand pressure only. (393.209(d))

***Operational Policy 15 – Inspection/Regulatory Guidance: Regulatory Guidance 9.b.(1) – Ball and Socket Violations***

(3) Any obvious welded repair(s). (393.209(d))

\*h. Tie Rods and Drag Links

(1) Loose clamp(s) or clamp bolt(s) on tie rods or drag links. (396.3(a)(1))

(2) Any looseness in any threaded joint. (396.3(a)(1))

\*(3) When a drag link is so worn to cause a non-manufactured hole. (396.3(a)(1))

i. Nuts

Loose or missing on tie rods, pitman arm, drag link, steering arm or tie rod arm.  
(396.3(a)(1))

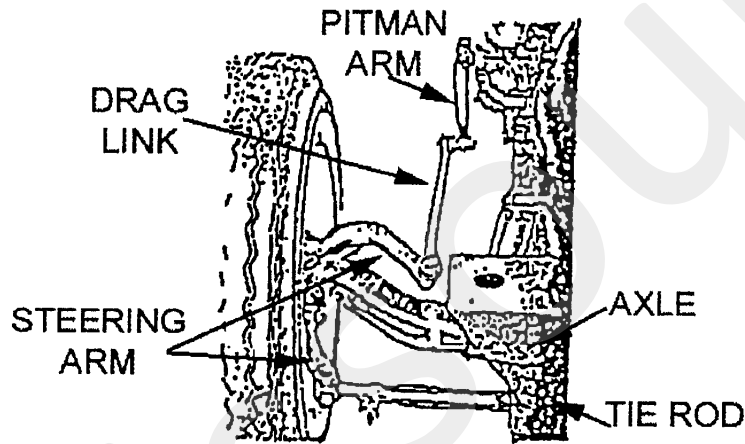

j. Steering System

Any modification or other condition that interferes with free movement of any steering component. (393.209(d))

k. C-Dolly

(1) Missing or inoperable steering locks. (396.3(a)(1))

(2) Steering not centered in the "zero" locked position. (396.3(a)(1))

**\*11. SUSPENSIONS**

a. Axle Parts/Members

(1) Any u-bolt(s) or other spring to axle clamp bolt(s) cracked, broken, loose or missing. (393.207(a))

***Operational Policy 15 – Inspection/Regulatory Guidance: OOS Frequently Asked Questions 10.a.(1) – Spring Eye U-Bolt***



- (2) Any axle, axle housing, spring hanger(s) or other axle positioning part(s) cracked, broken, loose or missing resulting in shifting of an axle from its normal position. (393.207(a))

**NOTE:** After a turn, lateral axle displacement is normal with some suspensions including composite springs mounted on steering axles.

***Operational Policy 15 – Inspection/Regulatory Guidance: OOS Frequently Asked Questions 10.a.(2) – Rebound Bolts***

b. Spring Assembly

- (1) 25 percent or more of the leaves in any spring assembly broken. (393.207(c))
- (2) Any leaf or portion of any leaf in any spring assembly is missing or separated. (393.207(c))
- (3) Any broken main leaf in a leaf spring. (393.207(c))

***Operational Policy 15 – Inspection/Regulatory Guidance: OOS Frequently Asked Questions 10.a.(3) – Cross Tube Brace***

**NOTES:**

1. Any leaf of leaf spring assembly is a main leaf if it extends at both ends to or beyond:
  - a. The load-bearing surface of a spring hanger or equalizer.
  - b. The spring end cap or insulator box mounted on the axle.
  - c. A spring eye, further: Any leaf or a helper spring assembly is a helper main leaf if it extends at both ends to or beyond the load-bearing surface of its contact pad, hanger or equalizer.
2. The suspension connecting leaf, in springs having such a leaf, has the same function as the suspension connecting rod components referenced in “Suspension Connecting Rod, Tracking Component Assembly or Sway Bar Components” and should be treated as such a component for purposes of out of service.

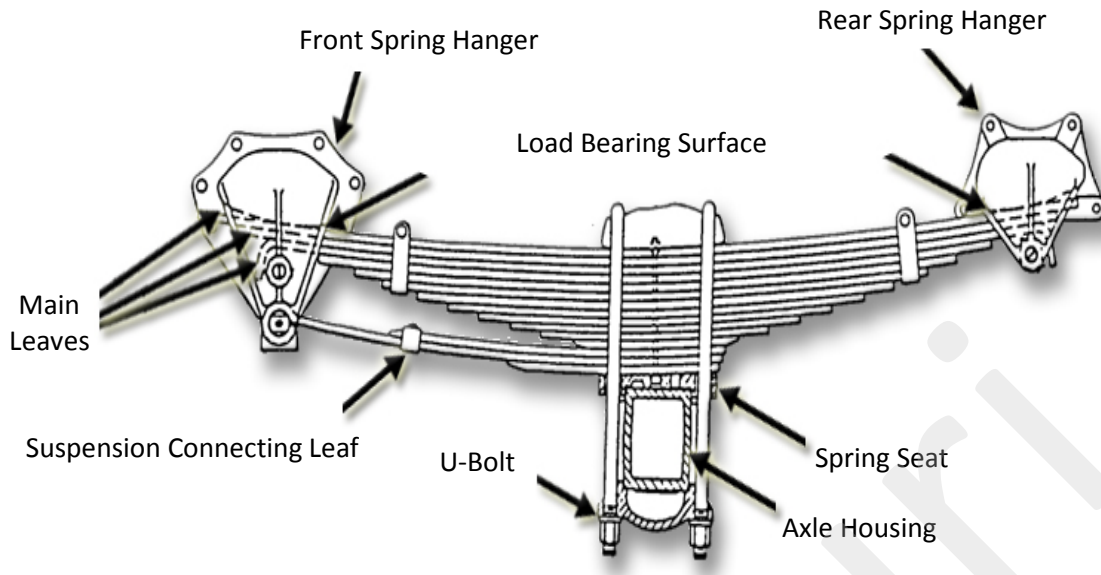

- (4) Coil spring broken. (393.207(d))
- (5) Rubber spring missing. (393.207(a))
- (6) One or more leaves displaced in a manner that could result in contact with a tire, rim, brake drum or frame. (393.207(c))
- (7) Broken torsion bar spring in torsion bar suspension. (393.207(e))
- (8) Air Suspension
  - (a) Deflated air suspension (one or more deflated air spring/bag). (393.207(f))

**NOTE:** Deflated aftermarket/secondary air bag suspension in addition to a primary leaf/coil spring suspension does not result in an out-of-service condition.

**Operational Policy 15 – Inspection/Regulatory Guidance: OOS  
Frequently Asked Questions 10.a.(4) – Aftermarket/Secondary Air Bags**

- (b) Air spring/bag is missing or is detached at the top or bottom. (393.207(f))

c. Composite Springs

- (1) Intersecting cracks of any length. (393.207(c))
- (2) A crack that extends beyond 75 percent of the length of the spring. (393.207(c))

**NOTE:** A crack is a separation in any axis which passes completely through the spring.

Intersecting cracks of any length.

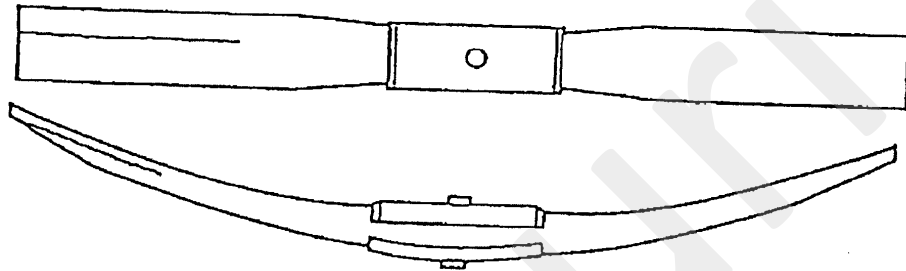

Side to side crack extending beyond 75 percent of the length of the spring. (A crack that extends beyond 75 percent of the length of the spring.)

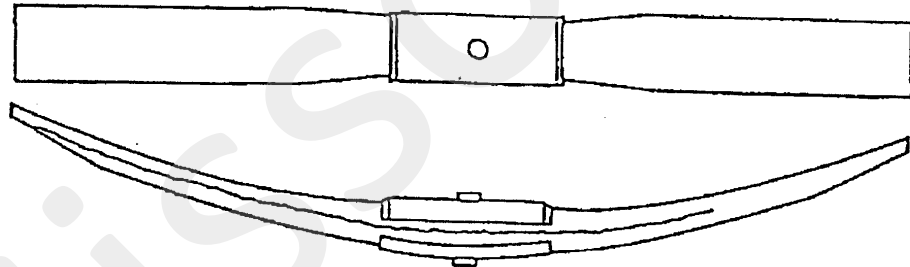

Top to bottom crack extending beyond 75 percent of the length of the spring. (A crack that extends beyond 75 percent of the length of the spring.)

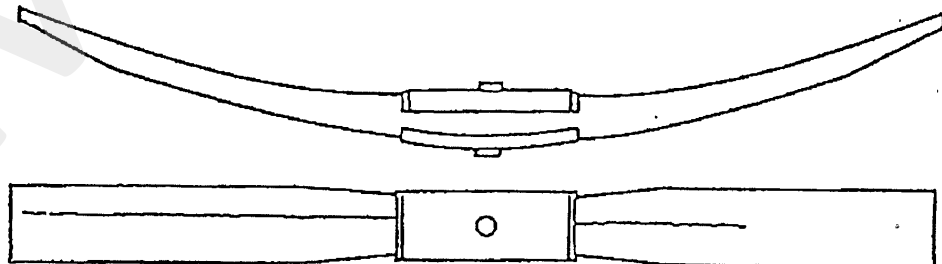

d. Suspension Connecting Rod, Tracking Component Assembly or Sway Bar Components

- (1) Any part of a suspension connecting rod or tracking component assembly (including spring leaves used as a suspension connecting rod) or any part used for attaching same to the vehicle frame or axle that is cracked, loose, broken or missing. (393.207(a))

**Operational Policy 15 – Inspection/Regulatory Guidance: OOS Frequently Asked Questions 10.a.(2) – Rebound Bolts**

**Operational Policy 15 – Inspection/Regulatory Guidance: OOS Frequently Asked Questions 10.a.(3) – Cross Tube Brace**

- (2) Any part of a suspension connecting rod or tracking component assembly (including spring leaves used as a suspension connecting rod) equipped with rubber bushings is missing the bushing or the bushing is worn to the extent that the component can be moved by hand along the axis of the component. (393.207(a))

**NOTE:** A shock absorber is not a suspension connecting rod. A defective shock absorber will not result in an out-of-service condition.

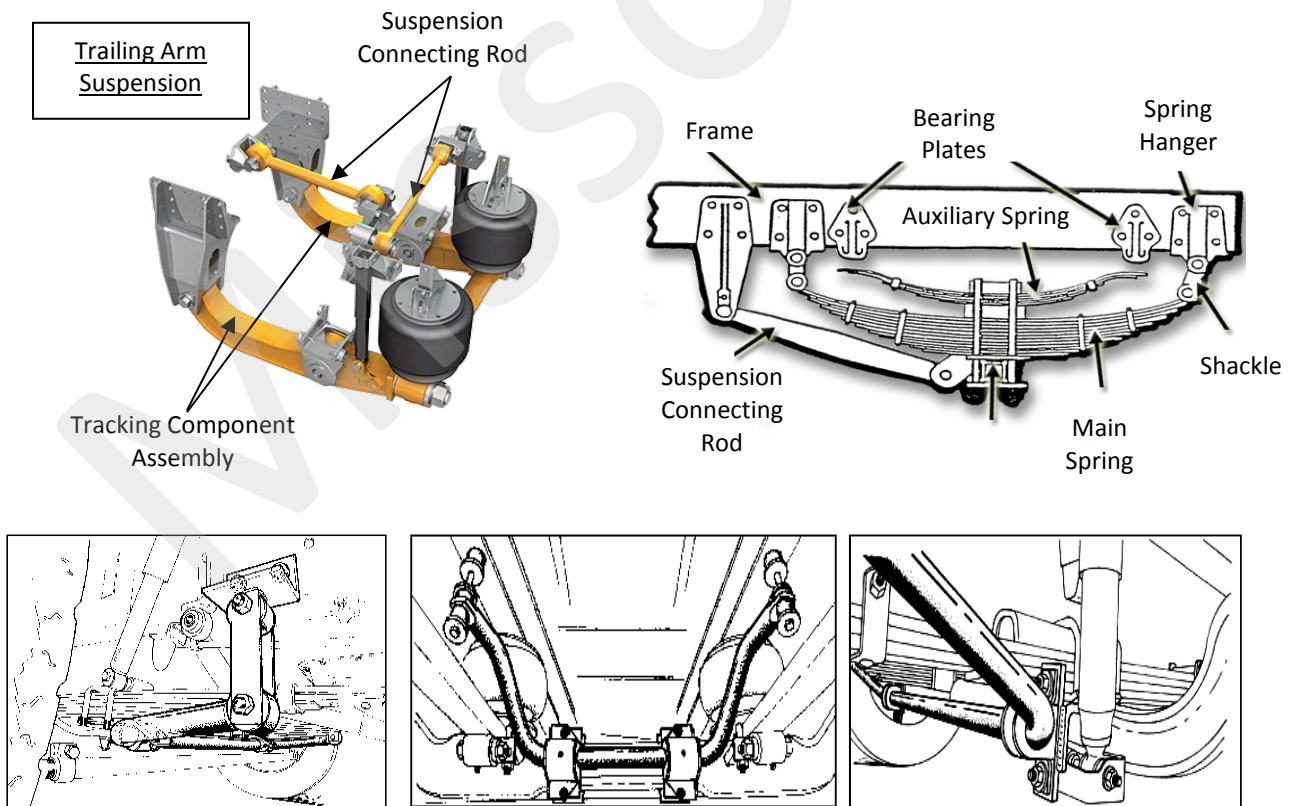

e. Adjustable Axle(s)/Sliding Trailer Suspension System

- (1) More than 25 percent of the locking pins or locking pin holes that are in use meet any of the following conditions:
  - (a) Locking pin is missing or not engaged. (393.207(b))
  - (b) A locking-pin hole measures more than 1 inch (25.4 mm) larger than its original size. (396.3(a)(1))
  - (c) The material from the hole in use to an adjacent hole, or the material from the hole in use to the edge of the rail, is torn or split. (396.3(a)(1))
- (2) More than 25 percent of the slider-guide/hold-down brackets are missing or disengaged. (396.3(a)(1))
- (3) The sliding suspension attachment member (undercarriage body rail) on either side exhibits a crack of any length in more than 50 percent of its attachment welds. (396.3(a)(1))
- (4) A sliding suspension member's (undercarriage body rail) attachment welds are cracked completely through along a 4 foot (1.2 m) continuous length of the body rail. (396.3(a)(1))
- (5) A sliding suspension attachment member (undercarriage body rail) is cracked completely through along a 4 foot (1.2 m) continuous length. (396.3(a)(1))
- (6) The sliding suspension attachment member (undercarriage body rail) attachment fasteners are missing along a 4 foot (1.2 m) continuous length of the body rail. (396.3(a)(1))
- (7) The sliding suspension attachment member (undercarriage body rail) on either side exhibits 50 percent or more of attachment fasteners missing. (396.3(a)(1))

**\*12. TIRES**

a. Any Tire on Any Front Steering Axle(s) of a Power Unit

- (1) With less than 2/32 inch (1.6 mm) tread when measured in any two adjacent major tread grooves (typically any groove containing a tread wear indicator) at any location on the tire. (393.75(b))

**NOTE:** Measurements should not be made on stone ejectors or tread wear indicators.

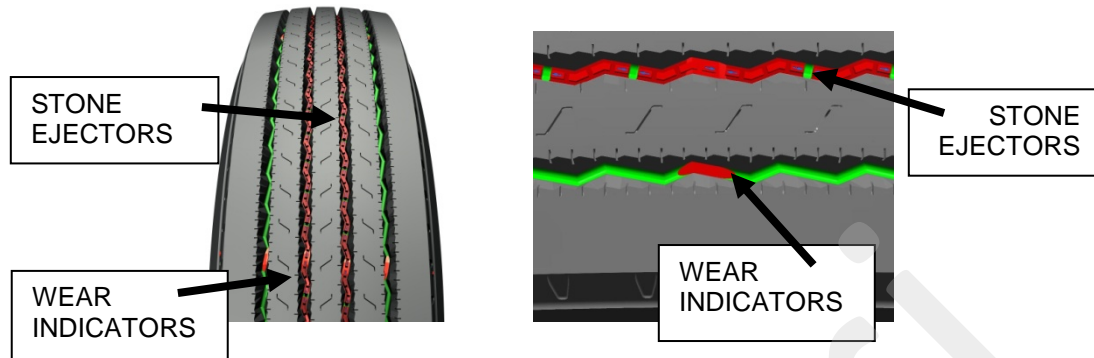

**Operational Policy 15 – Inspection/Regulatory Guidance: OOS Frequently Asked Questions 11.a.(1) – Major Tread Groove**

- (2) When any part of the belt material, breaker strip or casing ply is showing in the tread. (393.75(a)(1))
- (3) When sidewall is cut, worn or damaged to the extent that the steel or fabric ply cord is exposed. (393.75(a)(1))
- (4) Labeled “Not For Highway Use” or carrying other markings that indicate excluded use on steering axles. (396.3(a)(1))
- (5) Visually observable bump, bulge or knot apparently related to tread or sidewall separation. (393.75(a)(2))

**EXCEPTION:** A bulge (due to a repair) of up to 3/8 inch (9.5 mm) in height is allowed. This bulge may sometimes be identified by a blue triangular label in the immediate vicinity.

- (6) Presence of rubber-coated cord or cured rubber plug in the sidewall. (396.3(a)(1))
- (7) Tire has noticeable (e.g., can be heard or felt) leak, or has 50 percent or less of the maximum inflation pressure marked on the tire sidewall. (393.75(a)(3))

**NOTE:** Measure tire air pressure only if there is evidence the tire is under-inflated.

**Operational Policy 15 – Inspection/Regulatory Guidance: Regulatory Guidance 11.b.(1) – Tire Inflation Pressure**

- (8) So mounted or inflated that it comes in contact with any part of the vehicle. (396.3(a)(1))

**NOTE:** An out-of-service condition exists only if the tire can be made to contact another component at the time of inspection.

- (9) Weight carried exceeds tire load limit. This includes overloaded tire resulting from low air pressure. (Load Limit - 393.75(g) or Inflation Pressure - 393.75(i))

**EXCEPTION:** Does not apply to vehicles being operated under the special permit exclusion. (393.75(g)(1))

- (10) Passenger-Carrying Vehicle: Regrooved, recapped or retreaded tires on front steering axles. (393.75(d))

b. All Tires Other Than Those Found on the Front Steering Axle(s) of a Powered Unit

- (1) Tire has noticeable (e.g., can be heard or felt) leak, or has 50 percent or less of the maximum inflation pressure marked on the tire sidewall. (393.75(a)(3))

**NOTE:** Measure tire air pressure only if there is evidence the tire is under-inflated.

- (2) Any tire with visually observable bump or knot apparently related to tread or sidewall separation. (393.75(a)(2))

**EXCEPTION:** A bulge (due to a repair) of up to 3/8 inch (9.5 mm) in height is allowed. The bulge may sometimes be identified by a blue triangular label in the immediate vicinity.

- (3) So mounted or inflated that it comes in contact with any part of the vehicle. (396.3(a)(1))

**NOTE:** This includes any tire contacting its mate in a dual set.

- (4) Weight carried exceeds tire load limit. This includes overloaded tire resulting from low air pressure. (Load Limit - 393.75(g) or Inflation Pressure - 393.75(i))

**EXCEPTION:** Does not apply to vehicles being operated under the special permit exclusion. (393.75(g)(1))

- (5) 75 percent or more of the tread width loose or missing in excess of 12 inches (30.4 cm) in circumference. (393.75(a)(2))

- (6) Bias Ply Tire: When more than one ply is exposed in the sidewall and the area exceeds 2 square inches (12.9 sq cm). (393.75(a)(1))

- (7) Radial Ply Tire: When more than one ply is exposed in the sidewall and the area exceeds 2 square inches (12.9 sq cm). (393.75(a)(1))

**The following conditions apply to all tires; however, when these conditions are found on a dual tire set, both tires must meet one or more of the conditions listed in item 11.b.**

- (8) Bias Ply Tire: When more than one ply is exposed in the tread area and the exposed area of the top ply exceeds 2 square inches (12.9 sq cm) or damaged plies are evident in the sidewall up to 2 square inches (12.9 sq cm). (393.75(a)(1))
- (9) Radial Ply Tire: When two or more plies are exposed in the tread area and the exposed area of the top ply exceeds 2 square inches (12.9 sq cm) or damaged cords are evident in the sidewall up to 2 square inches (12.9 sq cm). (393.75(a)(1))
- (10) Presence of rubber-coated cord or cured rubber plug in the sidewall. (396.3(a)(1))
- (11) So worn that less than 1/32 inch (.8 mm) tread remains when measured in any two adjacent major tread grooves (typically any groove containing a tread wear indicator) at three separate locations around the circumference of the tire at least 8 inches (203.2 mm) apart. (393.75(c))

**NOTE:** Measurements should not be made on stone ejectors or tread wear indicators.

***Operational Policy 15 – Inspection/Regulatory Guidance: OOS Frequently Asked Questions 13.a.(1) – Removing a Wheel/Chaining Up an Axle***

c. Lodged Items Between Tires of a Dual Tire Set

Any solid item lodged between a set of dual tires that is in direct contact with the sidewalls of the tires (excluding mud and snow). (396.7(a))

**\*13. VAN AND OPEN-TOP TRAILER BODIES**

a. Upper Rail

- (1) Broken with complete separation of the flange. (393.201(a))
- (2) Buckled or cracked when accompanied by missing, working (movement under stress) or loose fasteners at adjacent roof bows and/or side posts. (393.201(a))
- (3) Buckled or cracked when accompanied by broken, ineffective or missing adjacent roof bows. (393.201(a))



b. Lower Rail

- (1) Broken with complete separation in the bay area accompanied by sagging floor, rail or crossmember; or broken with loose, working (movement under stress) or missing fasteners at side posts adjacent to the crack. (393.201(a))

**NOTE:** The lower rail of a van or open-top trailer can become gouged, chunked or bent during operation. These are superficial damages only and do little to degrade the rail's strength or integrity.

- (2) Drop frame trailers showing twists, bends or fatigue cracking at the drop frame's elevation changes. (393.201(a))

c. Floor Crossmembers

- (1) Three or more adjacent broken, and/or completely detached from and sagging below the lower rail in the bay area. (393.201(a))
- (2) Broken floor accompanied by protruding freight and sagging crossmembers. (393.201(a))

d. Side Panels on Fiberglass Reinforced Plywood (FRP) Trailers

Damage in the bay area that penetrates completely through the fiberglass and plywood resulting in a sagging lower rail. (393.201)

**NOTES:** The following apply to all items under "Van and Open-Top Trailer Bodies."

1. These conditions are only considered out of service if the failure is in the bay area (aft of kingpin coupler plate and forward of the axle sub frame rails).
2. Trailers 30 feet (9.14 m) or less in length have a short bay area and are not as susceptible to catastrophic failures; therefore, only rail breaks accompanied by a sagging floor, rail or crossmember are out of service for them.
3. Rail, post, bow, crossmember and side/front panel damage in areas outside the bay area are not imminently hazardous and should not be considered out of service unless they lead to conditions described in other items of the North American Standard Out-of-Service Criteria.

**\*14. WHEELS, RIMS AND HUBS**

a. Lock or Side Ring

Bent, broken, cracked, improperly seated, sprung or mismatched ring(s). (393.205(a))

b. Rim Cracks

Any circumferential crack. (393.205(a))

c. Disc Wheel Cracks

(1) Any crack exceeding 3 inches (76.2 mm) in length. (393.205(a))

(2) A crack extending between any two holes (hand holes, stud holes and center holes). (393.205(a))

(3) Two or more cracks anywhere on the wheel. (393.205(a))

d. Bolt/Stud Holes (Disc Wheels)

Any visible elongated bolt/stud hole. (393.205(b))

e. Spoke Wheel Cracks

(1) Two or more cracks more than 1 inch (25.4 mm) long across a spoke or hub section. (393.205(a))

(2) Two or more web areas with cracks. (393.205(a))

f. Tubeless Demountable Adapter Cracks

(1) A crack exceeding 3 inches (76.2 mm). (393.205(a))

(2) Cracks at three or more spokes. (393.205(a))

g. Wheel Fasteners

Loose, missing, broken, cracked or stripped wheel fasteners that are ineffective as follows: for 10 fastener positions - 3 anywhere or 2 adjacent; for 8 fastener positions or less - 2 anywhere (this applies to both spoke and disc wheels). (393.205(c))

h. Welds

(1) Any cracks in welds attaching disc wheel to rim. (393.205(a))

(2) Any crack in welds attaching tubeless demountable rim to adapter. (393.205(a))

(3) Any welded repair on any aluminum wheel(s). (396.3(a)(1))

(4) Any welded repair other than disc to rim attachment on steel disc wheel(s). (396.3(a)(1))

i. Hubs

(1) When any bearing (hub) cap, plug or filler plug is missing or broken allowing an open view into hub assembly. (396.3(a)(1))

(2) Smoking from wheel hub assembly due to bearing failure. (396.3(a)(1))

**NOTE:** Refer to "Brake Systems – Brake Smoke/Fire," as the cause may either be the brakes or a problem in the hub and bearing area.

(3) When any wheel seal is leaking. This must include evidence of wet contamination of the brake friction material and accompanied by evidence that further leaking will occur. (396.5(b))

**NOTE:** Refer to the applicable contaminated friction material criterion in "Brake Systems," when condition is present.

**NOTE:** Grease/oil on the brake lining edge, back of shoe, or drum edge and oil stain with no evidence of fresh oil leakage are not conditions for out of service.

(4) Lubricant is leaking from the hub and is present on the wheel surface (caused by a loose hub cap or hub cap bolts, or hub cap damage) accompanied by evidence that further leakage will occur. (396.5(b))

(5) No visible or measurable amount of lubricant showing in hub. (396.5(a))

***Operational Policy 15 – Inspection/Regulatory Guidance: OOS Frequently Asked Questions 13.a.(1) – Removing a Wheel/Chaining Up an Axle***

**\*15. WINDSHIELD WIPERS**

Any power unit that has an inoperative wiper or missing, or damaged parts that render it ineffective on the driver's side. (Applicable only in inclement weather requiring use of windshield wipers.) (393.78(a) or 393.78(b))

**\*16. BUSES, MOTORCOACHES, PASSENGER VANS OR OTHER PASSENGER-CARRYING VEHICLES – EMERGENCY EXITS/ELECTRICAL CABLES AND SYSTEMS IN ENGINE AND BATTERY COMPARTMENTS/SEATING (TEMPORARY AND AISLE SEATS)**

a. Emergency Exits

Required and/or marked emergency exits that are missing, inoperative (does not open, close and/or secure as designed), or obstructed. (393.62)

b. Electrical Cables and Systems in Engine and Battery Compartments

- (1) Electrical cable insulation chafed, frayed, damaged, burnt, causing bare cable to be exposed. (393.28)
- (2) Missing or damaged protective grommets insulating electrical cables through metal compartment panels. (393.28)
- (3) Broken or unsecured mounting of electrical components. (396.3(a)(1))
- (4) Electrical cables unsupported, hanging or missing clamps that may cause a chafing or frayed condition. (393.28)

**NOTE:** A cable is the power-conveying part of a high wattage/voltage electrical system. It usually has no circuit overload protection included in the system (i.e., battery to electrical starter or alternator to battery).

c. Loose and/or Temporary Seating

- (1) No bus, motorcoach, passenger van or other passenger-carrying vehicle:
  - (a) Shall be equipped with aisle seats unless such seats are so designed and installed as to automatically fold and leave a clear aisle when they are unoccupied. (393.91)
  - (b) Shall be operated if any temporary seating, occupied or not, therein is not secured to the vehicle in a workman-like manner. This includes the use of items not designed for use as seats in vehicles, including but not limited to, milk crates, folding chairs, plastic steps or plastic stools. (393.91)
  - (c) Shall be operated with the presence of any seating, whether secured or unsecured, in excess of the manufacturer's (manufacturer, remanufacturer, or final stage manufacturer) designed seating capacity. (390.33)

**NOTE:** (a), (b) or (c) does not apply to mobility devices (such as wheel chairs) secured in vehicles using proper tiedowns.

## Part III

### NORTH AMERICAN STANDARD HAZARDOUS MATERIALS/DANGEROUS GOODS OUT-OF-SERVICE CRITERIA

#### POLICY STATEMENT

The purpose of this part is to provide criteria for the abatement of unsafe conditions in the transportation of hazardous materials/dangerous goods and is based upon the presence of any condition(s) which fail(s) to communicate the hazard(s) or is an imminent hazard.

Except where state, provincial, territorial or federal laws preclude enforcement of a named item, motor carrier safety enforcement personnel and their jurisdictions shall comply with these out-of-service violation standards.

**OUT OF SERVICE:** Condition(s) categorized in this document as “out of service” shall not be allowed to continue in commerce until the out-of-service condition(s) is/are fully corrected and complies with the applicable regulations. If, at the discretion of the inspector, it is less hazardous to the public to relocate the vehicle, it shall be towed, transported or escorted to a safe location only at the direction of an official authority.

When a vehicle is declared out of service for a condition, all violations that contributed to the specific out-of-service condition must be repaired (e.g., a vehicle declared out of service for 50 percent or more missing placards must have all missing placards replaced prior to being released).

An out-of-service condition cannot be corrected by creating a new violation (e.g., if a vehicle is declared out of service for two missing placards, an otherwise compliant placard cannot be removed from another vehicle in the combination if such removal would create a violation on that other vehicle).

When a U.S. DOT/Transport Canada specification cargo tank inspection is completed in conjunction with the North American Standard Level I and/or Level V Inspection CVSA decals shall not be issued to U.S. DOT/Transport Canada specification cargo tank vehicles found to have violations of the following:

- Retest Requirements
- Cargo Tank Authorization
  - Does not include specification shortages
- Manhole Covers
- Internal Valves
- Discharge Valves
- Cargo Tank Integrity
- Supports and Anchoring
- Double Bulkhead Drains
- Ring Stiffeners
- Rear End Protection
- Emergency Flow Control
- Piping and Protection
- Overturn Protection
- Venting

**\*1. SHIPPING PAPERS**

**\*a. General**

Transporting hazardous materials/dangerous goods (HM/DG) not accompanied by a shipping paper clearly identifying the specific HM/DG being transported.

**NOTE:** An error in the shipping description or an incomplete shipping description that will not impede emergency response does not constitute an out-of-service condition.

**\*2. PLACARDING**

**\*a. Placards Displayed on a Transport Vehicle**

\* (1) 50 percent or more of the required placards for a hazard class are missing.

\* (2) Any placard(s) misrepresent(s) the HM/DG being transported.

**NOTE:** For this out-of-service item to apply, HM/DG must be present.

*Inspection Bulletin 2017-03 – Display of GHS Labels on Bulk Packages*

**\*3. BULK PACKAGES**

**\*a. Internal Valve (Missing)**

The internal valve is missing when required.

**\*b. Internal Valve (Open)**

The internal valve is in the open position.

**\*c. Bulk Package Authorization**

Transporting HM/DG in a bulk package not authorized for the material being transported. Unless otherwise indicated herein, specification shortages shall not disqualify an otherwise authorized package.

**\*d. Venting Devices, Manhole Covers, Fill/Inspection Openings and Discharge Valves**

Missing or improperly secured venting devices, manhole covers, fill/inspection openings or discharge valves.

**\*e. Bulk Package Integrity**

HM/DG leaking from a bulk package (including associated piping).

**\*f. Supports and Anchoring**

More than 25 percent of the supporting and/or anchoring mechanisms are ineffective.

**NOTE:** A bulk package which is also an intermodal container must also be secured in accordance with “Cargo Securement” in Part II.

**\*4. TRANSPORT VEHICLE MARKINGS**

**\*a. ID Numbers Displayed on a Transport Vehicle**

**\*(1)** 50 percent or more of the required ID numbers are missing for each material.

**\*(2)** Any ID number misrepresents the material transported.

**NOTE:** The ID numbers may be displayed on orange panels, a white square-on-point configuration or incorporated with the placards.

**NOTE:** In Canada required placards and markings must be displayed on four sides of all large means of containment.

**NOTE:** For this out-of-service item to apply, an HM/DG must be present.

**\*5. POISON INHALATION HAZARD (PIH) MARKINGS**

**\*a. Non-Bulk Packaging**

Required markings are missing or illegible.

**\*b. Bulk Packaging**

Required markings are missing or illegible.

**\*6. NON-BULK PACKAGING**

**\*a. Package Integrity**

HM/DG leaking in or from a package.

**\*7. LOADING AND SECUREMENT**

**\*a. Blocking and Bracing**

Transporting HM/DG not blocked, braced or secured as required by applicable regulation.

**NOTE:** Any shifting likely to adversely affect HM/DG package integrity, under conditions normally incident to transportation.

**b. Product Compatibility**

Transporting incompatible commodities constitutes an out-of-service condition, unless otherwise excepted.

c. Poison/Edible Materials

Transporting packages requiring “poison/toxic” or “poison/toxic –inhalation hazard” label(s) in the same vehicle with foodstuffs, feed or other edible materials intended for consumption by humans or animals constitutes an out-of-service condition, unless otherwise excepted.

**NOTE:** When initiating an out-of-service action, contact proper health authority within your jurisdiction.

**\*8. FORBIDDEN MATERIALS**

\*a. Forbidden Materials

Transporting forbidden materials.

**\*9. RADIOACTIVE MATERIALS – RADIATION LEVELS**

\*a. Measured at Surface of Vehicle

Measurement exceeds 2mSv/hr (200 mrem/hr), at accessible surface of vehicle.

**NOTE:** When initiating out-of-service action, contact the appropriate health physicists, or radiation agency within your jurisdiction.

**\*10. EMERGENCY RESPONSE ASSISTANCE PLAN (ERAP) (In Canada Only)**

HM/DG are transported in Canada without an approved ERAP when it is required.



## Part IV

### NORTH AMERICAN STANDARD ADMINISTRATIVE OUT-OF-SERVICE CRITERIA

#### POLICY STATEMENT

The purpose of this part is to identify violations that prohibit the motor carrier from operating the commercial motor vehicle until the condition is corrected. The violations in this section are important aspects of the motor carrier's ability to operate lawfully and to help enforcement personnel in maintaining uniformity across the industry.

The necessity for all enforcement personnel to implement and adhere to these standards is: (1) a matter of law; (2) perceived as necessary by the society we are charged with protecting; and (3) a professional obligation if substantial enhancement in the safety of commercial motor vehicle operators is to be achieved.

Except where state, provincial, territorial or federal laws preclude enforcement of a named item, motor carrier safety enforcement personnel and their jurisdictions shall comply with these out-of-service violation standards.

**OUT-OF-SERVICE VIOLATION:** Violations under this category preclude further operation of a commercial motor vehicle by the carrier for a specified period of time or, for some violations, until compliance with a specific requirement.

1. **OPERATING AUTHORITY**

Operating a commercial motor vehicle without the required operating authority or beyond the scope of the motor carrier's operating authority. (Authority Required - 392.9a(a)(1) or Beyond Scope - 392.9a(a)(2)) **Declare vehicle out of service until the proper operating authority is obtained.**

2. **INACTIVE/NO USDOT NUMBER**

a. **Inactive USDOT Number**

When required to have a USDOT number, operating a commercial motor vehicle with a "de-activated" or "inactive" USDOT number. (392.9b(a)) **Declare vehicle out of service until USDOT number is "active."**

b. **No USDOT Number**

Operating a commercial motor vehicle with no USDOT number when required and a history of operating a commercial motor vehicle with no USDOT number when required. (392.9b(a)) **Declare vehicle out of service until a USDOT number has been obtained.**

3. **MEXICO-DOMICILED CARRIERS OPERATING IN THE U.S.**

A Mexico-domiciled carrier (USDOT X Number) granted provisional operating authority pursuant to 49 CFR 365 operating a commercial motor vehicle in the United States that does not display a current CVSA decal on the power unit. (385.103(c)) **Declare vehicle out of service until the vehicle satisfactorily passes an inspection and a CVSA decal is issued.**

4. **U.S. FEDERAL OUT-OF-SERVICE ORDERS**

Operating a commercial motor vehicle while an existing motor carrier out-of-service order, issued by the Federal Motor Carrier Safety Administration (FMCSA) is in effect. (Choose from the list of 14 sections of the Federal Motor Carrier Safety Regulations (FMCSRs) listed on the following page.) **Declare vehicle out of service until such time as the motor carrier out-of-service order issued by FMCSA has been satisfied.**

Description	Section
Failure to Pay Fine – Private Carrier	386.83(a)(1)
Failure to Pay Fine – For-Hire Carrier	386.83(a)(1)
UNSAT/UNFIT – Placarded HM	385.13(a)(1)
UNSAT/UNFIT – Passenger Carriers	385.13(a)(1)
UNSAT/UNFIT – Property Carriers	385.13(a)(2)
New Entrant – Failure to Respond to Expedited Action Notification	385.308(d)
New Entrant – Failure of Safety Audit	385.325(c)
New Entrant – Refusal of Audit/No Contact	385.337(b)
Imminent Hazard – Motor Carrier	386.72(b)(4)
Imminent Hazard – Intermodal Equipment Provider	386.72(b)(4)
MX Carrier – Inadequate Corrective Action	385.105(b)
MX Carrier – UNSAT/UNFIT	385.111(a)
MX Carrier – Suspended Operating Authority for UNSAT Rating or Failed Safety Audit	385.111(c)(1)
MX Carrier – Revoked Operating Authority	385.111(c)(2)

**Enforcement Guidance:** All out-of-service orders must be confirmed. Vehicles shall only be declared out of service after online or telephonic verification of the motor carrier’s out-of-service order.

## Appendix

### NORTH AMERICAN STANDARD OUT-OF-SERVICE CRITERIA

#### POLICY STATEMENT

The information contained/included in this Appendix is provided as a reference and/or guidance on roadside commercial motor vehicle enforcement activities and CVSA decal applicability and application. For more detailed and current information regarding the roadside North American Standard Inspection Program, refer to the Alliance bylaws, operational policy, and/or inspection procedures.

Missouri

## \*North American Standard Inspection Levels

### Level I

**North American Standard Inspection** – An inspection that includes examination of driver’s license; Medical Examiner’s Certificate and Skill Performance Evaluation (SPE) Certificate (if applicable); alcohol and drugs; driver’s record of duty status, as required; hours of service; seat belt; vehicle inspection report(s) (if applicable); brake systems; cargo securement; coupling devices; driveline/driveshaft; exhaust systems; frames; fuel systems; lighting devices (headlamps, tail lamps, stop lamps, turn signals and lamps/flags on projecting loads); steering mechanisms; suspensions; tires; van and open-top trailer bodies; wheels, rims and hubs; windshield wipers; buses, motor coaches, passenger vans or other passenger-carrying vehicles – emergency exits, electrical cables and systems in engine and battery compartments, seating, HM/DG and specification cargo tank requirements, as applicable. HM/DG required inspection items will only be inspected by certified HM/DG and cargo tank inspectors, as applicable.

**NOTE:** If more than 20 percent of pushrod travel on exposed pushrods cannot be measured, then the inspection would not be considered a Level I Inspection and shall be identified as a Level II Inspection.

**NOTE:** A 5-axle vehicle combination with one axle not measured will still require two defective brakes to be placed out of service under the 20 percent criteria.

### Level II

**Walk-Around Driver/Vehicle Inspection** – An examination that includes each of the items specified under the North American Standard Level II Walk-Around Driver/Vehicle Inspection Procedure. As a minimum, Level II Inspections must include examination of: driver’s license; Medical Examiner’s Certificate and Skill Performance Evaluation (SPE) Certificate (if applicable); alcohol and drugs; driver’s record of duty status as required; hours of service; seat belt; vehicle inspection report(s) (if applicable); brake systems; cargo securement; coupling devices; driveline/driveshaft; exhaust systems; frames; fuel systems; lighting devices (headlamps, tail lamps, stop lamps, turn signals and lamps/flags on projecting loads); steering mechanisms; suspensions; tires; van and open-top trailer bodies; wheels, rims and hubs; windshield wipers; buses, motor coaches, passenger vans or other passenger-carrying vehicles – emergency exits, electrical cables and systems in engine and battery compartments, seating, and HM/DG requirements, as applicable. HM/DG required inspection items will only be inspected by certified HM/DG and cargo tank inspectors, as applicable. It is contemplated that the walk-around driver/vehicle inspection will include only those items that can be inspected without physically getting under the vehicle.

### Level III

**Driver/Credential/Administrative Inspection** – An examination that includes those items specified under the North American Standard Level III Driver/Credential/Administrative Inspection Procedure. As a minimum, Level III Inspections must include, where required and/or applicable: examination of the driver’s license; Medical Examiner’s Certificate and Skill Performance Evaluation (SPE) Certificate; driver’s record of duty status; hours of service; seat belt; vehicle inspection report(s); carrier identification and status.

**NOTE:** Mechanical equipment violations specific to a Level I or Level II Inspection should not be included in a Level III Inspection. If applicable, traffic violations/infractions should be included on a Level III Inspection.

#### **Level IV**

**Special Inspections** – Inspections under this heading typically include a one-time examination of a particular item. These examinations are normally made in support of a study or to verify or refute a suspected trend.

#### **Level V**

**Vehicle-Only Inspection** – An inspection that includes each of the vehicle inspection items specified under the North American Standard Level I Inspection, without a driver present, conducted at any location.

#### **Level VI**

**North American Standard Inspection for Transuranic Waste and Highway Route Controlled Quantities (HRCQ) of Radioactive Material** – An inspection for select radiological shipments, which include inspection procedures, enhancements to the North American Standard Level I Inspection, radiological requirements, and the North American Standard Out-of-Service Criteria for Transuranic Waste and Highway Route Controlled Quantities (HRCQ) of Radioactive Material.

As of Jan. 1, 2005, all vehicles and carriers transporting HRCQ of radioactive material are regulated by the U.S. Department of Transportation (DOT) and required to pass the North American Standard Level VI Inspection.

Previously, U.S. Department of Energy (DOE) voluntarily complied with the North American Standard Level VI Inspection Program requirements.

Select radiological shipments include HRCQ of radioactive material as defined by Title 49 CFR Section 173.403. And, because only a small fraction of transuranics are HRCQ, DOE decided to include its transuranic waste shipments in the North American Standard Level VI Inspection Program.

#### **Level VII**

**Jurisdictional Mandated Commercial Vehicle Inspection** – An inspection that is a jurisdictional mandated inspection program that does not meet the requirements of any other level of inspection. An example will include inspection programs such as, but not limited to: school buses; limousines; taxis; shared ride; hotel courtesy shuttles; and other intrastate/intraprovincial operations. These inspections may be conducted by CVSA-certified inspectors, other designated government employees or jurisdiction approved contractors. Inspector training requirements shall be determined by each jurisdiction. No CVSA decal shall be issued for a Level VII Inspection but a jurisdiction-specific decal may be applied.

#### **Level VIII**

**North American Standard Electronic Inspection** – An examination that includes those items specified under the North American Standard Electronic Inspection Procedure. An electronic inspection must include, where required and/or applicable, a descriptive location, including GPS coordinates; electronic validation of who is operating the vehicle; appropriate driver's license class and endorsement(s) for vehicle being operated; license status; valid Medical Examiner's Certificate and Skill Performance Evaluation (SPE) Certificate; current driver's record of duty status; hours-of-service compliance; USDOT or (Canada) NSC number; power unit registration; operating authority; Unified Carrier Registration (UCR) compliance; and federal out-of-service orders.

The North American Standard Level VIII Electronic Inspection is an inspection conducted electronically or wirelessly while the vehicle is in motion without direct interaction with an enforcement officer. To be considered a complete Level VIII Electronic Inspection, a data exchange must include each of the required and/or applicable data points listed in the CVSA North American Standard Level VIII Electronic Inspection definition.

The purpose of the Level VIII Inspection is to improve safety by increasing the number of interactions a jurisdiction has with industry and by providing additional options and strategies that allow jurisdictions to leverage technology while also increasing efficiency for industry.

### **Qualifying for CVSA Decals**

#### **General**

The North American Standard Level I and/or Level V are the only inspections that may result in issuance of a CVSA decal. To qualify for a CVSA decal, a vehicle must not have any critical vehicle inspection Item violations contained in CVSA Operational Policy.

Inspections must be performed and CVSA decals affixed by North American Standard Level I and/or Level V certified inspectors. The term “certified” means the government employee performing inspections and/or affixing CVSA decals must have first successfully completed a training program approved by the Alliance. CVSA decals, when affixed, shall remain valid for a period not to exceed three consecutive months. Vehicles displaying a valid CVSA decal generally will not be subject to re-inspection.

However, nothing shall prevent re-inspection of a vehicle or combination of vehicles bearing valid CVSA decals, under the conditions specified in the section titled, “Vehicle Re-Inspections.”

#### **\*Critical Vehicle Inspection Items**

- Brake Systems
- Cargo Securement
- Coupling Devices
- Driveline/Driveshaft
- Driver’s Seat (Missing)
- Exhaust Systems
- Frames
- Fuel Systems
- Lighting Devices (Headlamps, Tail Lamps, Stop Lamps, Turn Signals and Lamps/Flags on Projecting Loads)
- Steering Mechanisms
- Suspensions
- Tires
- Van and Open-Top Trailer Bodies
- Wheels, Rims and Hubs
- Windshield Wipers
- Buses, Motorcoaches, Passenger Vans or Other Passenger-Carrying Vehicles – Emergency Exits/Electrical Cables and Systems in Engine and Battery Compartments/Seating (Temporary and Aisle Seats)

Rear Impact Guards – when a required rear impact guard is inspected during a North American Standard Level I or V Inspection, a CVSA decal shall not be issued if violations are present.

## **Raised Lift Axle(s)**

Raised lift axles are to be inspected to ensure all components are secure and for conditions that adversely affect the vehicle's operation (e.g., air leaks, etc.). If a critical vehicle inspection item defect is discovered on the raised axle, the vehicle is not eligible to receive a CVSA decal and the defect should be documented in the notes section of the inspection report. The raised lift axle shall not be included in determining the total number of brakes on a vehicle combination for the 20 percent service brake calculation. If the raised lift axle is required to be lowered to comply with regulatory requirements in order to continue operation, the operator has the option to adjust or offload cargo. Otherwise the axle is subject to inspection.

## **CVSA Decals on Cargo Tanks**

When a U.S. DOT/Transport Canada specification cargo tank inspection is completed in conjunction with North American Standard Level I and/or Level V Inspection, CVSA decals shall not be issued to U.S. DOT/Transport Canada specification cargo tank vehicles found to have violations of the following:

- Retest Requirements
- Cargo Tank Authorization
  - Does not include specification shortages
- Manhole Covers
- Internal Valves
- Discharge Valves
- Cargo Tank Integrity
- Supports and Anchoring
- Double Bulkhead Drains
- Ring Stiffeners
- Rear End Protection
- Emergency Flow Control
- Piping and Protection
- Overturn Protection
- Venting

## **\*Vehicle Inspections**

Each vehicle (motorcoach, school bus, other bus, truck, truck tractor, semi-trailer, trailer, converter dollies, etc.) used singularly or in combination may qualify for a CVSA decal if it passes inspection, and a CVSA decal shall be applied. "Pass Inspection" means that during a North American Standard Level I or Level V Inspection no defects are found in the critical vehicle inspection items. In addition, when a required rear impact guard is inspected during a North American Standard Level I or V Inspection, a CVSA decal shall not be issued if violations are present.

For the purpose of a CVSA decal issuance, if no violation is detected during a North American Standard Level I or Level V Inspection due to a hidden part, other than pushrod stroke measurements, of the listed critical vehicle inspection items, then a CVSA decal shall be applied. However, if more than 20 percent of pushrod travel on exposed pushrods cannot be measured, then a CVSA decal shall not be applied. An inspector can still apply a CVSA decal even though his/her jurisdiction does not allow for the inspection of gaseous fuel systems.



The CVSA decal criteria apply only to the condition of the vehicle, not the driver. It is possible for a driver to be out of service and still have his or her vehicle qualify for a CVSA decal.

### **Vehicle Re-Inspections**

A critical vehicle inspection item violation(s) (out of service or otherwise) noted during a CVSA Level I Inspection that is successfully repaired on-site and re-inspected by the same inspector at the same inspection location will qualify for a CVSA decal as long as all previously noted critical vehicle inspection item violation(s) have been properly repaired. In such instances, only a re-inspection of the repaired violation(s) shall be done with a decal being applied to the vehicle and properly noted upon the original inspection.

Any vehicle that is repaired off-site or inspected by a different inspector shall be required to have a complete inspection conducted in order to obtain a CVSA decal.

Nothing within this policy shall require an inspector to re-inspect a vehicle, with that decision being left to the individual inspector and his/her agency.

For the purposes of uniformity in the application of this section and maximum maintenance of the reciprocity standard, re-inspection of a vehicle bearing a current and valid CVSA decal is contemplated under the following circumstances:

1. A North American Standard critical vehicle inspection item or out-of-service violation is detected.
2. A North American Standard Level IV (Special Inspection) exercise is involved.
3. A statistically based random inspection technique is being employed to validate an individual jurisdiction or regional out-of-service percentage.
4. Re-inspections are conducted to maintain CVSA North American Standard Inspection quality assurance.

### **Required Repairs for Out-of-Service Notices**

The following shall be the policy regarding required repairs for out-of-service notices:

No motor carrier shall require nor shall any person operate or any inspector release any commercial motor vehicle declared out of service until all repairs required by the out-of-service notice have been satisfactorily completed to where a violation(s) no longer exists.

When a vehicle is declared out of service for a condition resulting from an accumulation of violations, all violations that contributed to the specific out-of-service condition must be repaired (e.g., a vehicle or vehicles in combination declared out of service for 20 percent defective brake violations must have all the 20 percent defective brake violations repaired prior to being released; or, a vehicle declared out of service for two tires at less than 1/32 inch (0.8 millimeter) tread depth must have both tire violations repaired prior to the vehicle being released, etc.). Once all of the contributing out-of-service violations have been repaired on any vehicle in a combination, that specific vehicle in the combination is no longer considered to be out of service.

An out-of-service condition cannot be corrected by creating a new violation (e.g., if a vehicle is declared out of service for three missing wheel fasteners on one wheel, wheel fasteners from other wheels cannot be removed to correct this out-of-service condition, etc.).

When a vehicle is declared out of service, it may not be moved under its own power to a place of repair. The following are three exceptions:

1. Vehicles transporting hazardous materials/dangerous goods that require placarding may be escorted to a repair facility or safe parking place.
2. When the imminently hazardous condition is automatically removed by the disconnection of the power unit from a towed unit, the power unit may be moved. When such an out-of-service power unit is operated, the examination report must carry the notation, "Power unit not to be operated in combination with another vehicle until repaired." In these instances, a CVSA decal will not be issued.

There are three mechanical defect conditions, which meet this criterion:

- a. Defective coupling mechanism on the power unit
  - b. Defective trailer supply valve, as long as the tractor protection valve is functional
  - c. Defective emergency or service brake hoses or tubing between tractor and trailer
3. Vehicles transporting passengers that have been declared out of service for emergency exits that are missing, inoperative or obstructed may be moved by driver to a location where the out-of-service condition can be repaired. At no time will the vehicle be moved in this condition with passengers aboard.

#### **Location of CVSA Decals**

The location for affixing a CVSA decal on a power unit shall be on the lower right corner of the exterior surface of the passenger's windshield.

The location for affixing a CVSA decal on trailing units (trailers, full trailers, semi-trailers, converter dollies, etc.) shall be on the lower right corner as near the front as possible.

The location for a CVSA decal on a cargo tank semi-trailer shall be at eye-level near the right front of the cargo tank and on the lower right corner of the exterior surface of the passenger's windshield of a straight truck.

The location for a CVSA decal on passenger-carrying vehicles shall be on the glass portion (window) of the passenger door as close to inspector's eye-level as possible.

Any expired CVSA decal shall be removed before a new CVSA decal is affixed.

## CVSA Decal Application

The quarter in which an inspection is performed is indicated by the color of the CVSA decal issued.

Inspection Period	Color Code
January, February, March	Green
April, May, June	Yellow
July, August, September	Orange
October, November, December	White

The year of issuance shall be indicated by using the last number of the calendar year (e.g., 2019 shall be indicated by the number "9") and shall be printed at the top portion of the sticker, with the CVSA trademark logo printed directly below.

CVSA decals affixed on the first month of a new calendar quarter must have both upper corners removed. Those issued during the second month of the same quarter must have the upper right corner removed. No corners are removed from those CVSA decals issued during the last month of a calendar quarter.

CVSA decals, affixed, will remain valid for the month of issuance plus two months. For example, a CVSA decal issued on July 28 will expire September 30.

In general, vehicles displaying a valid CVSA decal are not subject to re-inspection. However, if a critical vehicle inspection item violation is detected on a vehicle with a current CVSA decal, nothing prohibits inspection of the vehicle.

Should inspection of a vehicle displaying a valid CVSA decal disclose vehicle maintenance inconsistent with the minimum inspection criteria, the CVSA decal must be removed. However, if the critical vehicle inspection item violation(s) found are repaired at the scene, the CVSA decal would not have to be removed. In those instances where a complete re-inspection is performed and no critical vehicle inspection item violations are detected or if the items are corrected at the scene, a new CVSA decal should be applied.

## **\*Inspection Bulletins**

- \*2018-04** — Air Disc Brake Inspection  
(Created 09-27-2018)
- \*2018-03** — Doleco USA Textile Link Tiedown Assembly  
(Created 09-27-2018)
- \*2018-02** — Motorcoach Monocoque Frame-Suspension Inspections  
(Revised 04-01-2019)
- 2017-05** — Handheld and Electronic Logging Devices (ELDs)  
(Revised 04-12-2018)
- 2017-04** — Medical Certification Information Available in Nlets  
(Created 12-06-2017)
- 2017-03** — Display of GHS Labels on Bulk Packages  
(Created 09-21-2017)
- 2017-02** — Securement of an Intermodal Container on a Container Chassis Vehicle  
(Created 04-27-2017)
- 2016-01** — Canadian Driver's Licenses and Required Proof of Medical Certification  
(Revised 09-21-2017)
- 2015-09** — Motorcoach Emergency Roof Hatch Inspections  
(Revised 04-27-2017)
- 2015-08** — Advancement in Motorcoach Air Brake Systems  
(Revised 04-27-2017)
- 2015-07** — How to Properly Identify Shipper Violations  
(Revised 04-27-2017)
- 2015-06** — Electric-Drive Commercial Vehicle Inspections  
(Revised 04-27-2017)
- 2015-05** — Advanced 6 X 2 Tractor Inspections  
(Revised 04-27-2017)
- 2015-04** — Enforcement of Medical Examiner's Certificate Integration with the Commercial Driver's License  
(Revised 09-21-2017)
- 2015-03** — Safety Inspection Procedures for Vehicles Equipped with Air Suspension  
(Revised 04-27-2017)

- 2015-02** — Safety Procedure for Lift Axle Inspection  
(Revised 04-27-2017)
- 2014-02** — Identification of Long Stroke Brake Chambers  
(Revised 04-27-2017)
- 2014-01** — Driveline/Driveshaft Inspections  
(Revised 09-27-2018)
- 2013-02** — Antilock Brake Systems (ABS) Inspections  
(Revised 12-08-2018; Field References Updated 04-27-2017)
- 2012-06** — Identifying Intermodal Equipment Providers for Intermodal Chassis  
(Revised 10-22-2018)
- 2012-05** — Automatic On-Board Recording Devices (AOBRDs)  
(Revised 12-06-2017)
- 2012-04** — Hydraulic Brake System Inspection and Trailer Inspection Procedures  
(Revised 09-27-2018)
- 2012-02** — Brake Pedal (Valve and Treadle Assembly) Inspections  
(Revised 04-27-2017)
- 2010-05** — MCI Buses with Detroit Diesel Engines  
(Revised 04-27-2017)
- 2010-03** — Rack and Pinion Steering System Inspection  
(Revised 04-01-2019)
- 2010-02** — Inspection of Vehicles Equipped with 2007 and Later EPA-Certified Engines  
(Revised 04-27-2017)
- 2010-01** — Tractor Protection Systems  
(Revised 04-27-2017)
- 2006-01** — Camshaft Bushings  
(Revised 04-27-2017)

**\*OPERATIONAL POLICY 15  
INSPECTION/REGULATORY GUIDANCE**

**PURPOSE**

Operational Policy 15 is intended to provide inspection and regulatory guidance pertaining to driver-vehicle inspections when using the recommended North American Standard Inspection Procedure. It also contains direction related to frequently asked questions related to the North American Standard Out-of-Service Criteria (OOSC).

**OBJECTIVES**

1. Clarify frequently asked questions related to the OOSC.
2. Provide guidance for regulations on an interim basis until such time as regulations can be amended.
3. Maintain an up-to-date policy to ensure guidances and interpretations outlined in the policy are current.
4. Out-of-service (OOS) clarifications are outlined as they are referenced in the OOSC.

**NOTE: Regulatory guidance should be used for all U.S. Federal Motor Carrier Safety Regulations (FMCSRs) and in Canada and Mexico where there is not specific regulation to supersede the guidance.**

***Documenting violations before the limits specified in the following guidance adversely impacts a carrier's safety rating unnecessarily and requires a carrier to spend time and money to repair a condition that presently does not affect the safe operation of the vehicle. Maintenance issues cannot be recorded as violations.***

The following are current interpretations and guidance:

**\*1. BRAKE SYSTEMS**

**OOS Frequently Asked Questions**

- a.(1) What is considered a proper air brake connection?

**ANSWER:** A proper air brake connection is a gladhand; two metal fittings joined together; or a push-to-connect fitting.

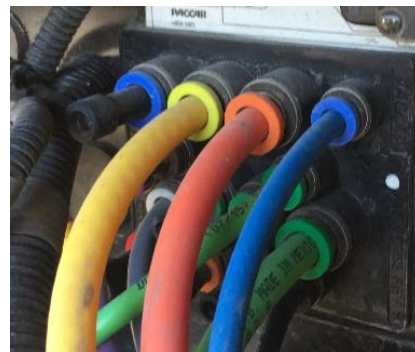

a.(2) When an air leak is found at a fitting, when should it be placed out of service?

**ANSWER:** An air hose with a leak at the hose side of a fitting is not considered a proper connection; therefore, it should be placed out of service.

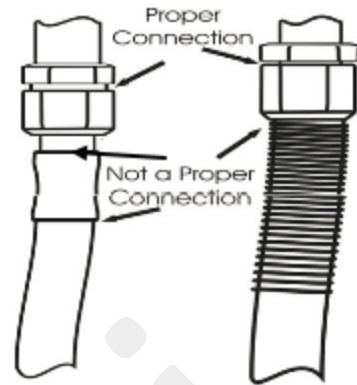

This is proper connection; a leak from this push-to-connect fitting is not OOS



### Regulatory Guidance

b.(1) When should cracks in brake linings (including rust jacking) not be recorded as a violation?

**ANSWER:** A violation should not be recorded until a crack exceeds the limit specified in the CVSA OOSC, e.g., until a crack exceeds 1/16 inch (1.6 mm) wide or 1 1/2 inch (38.1 mm) in length.

b.(2) When should air hoses and tubing not be documented as a violation for chafing?

**ANSWER:** A violation should not be recorded until a reduction of the hose diameter is observed. It is not a violation if the hoses/lines rest on, or lightly rub on vehicle components. A hose that is found to have a reduction in diameter but is no longer chafing does not constitute a violation unless damage extending to or through the outer reinforcement ply is observable. When damage extends to or through the outer reinforcement ply, a violation will be recorded (thermoplastic nylon tubing that is discolored or faded but not damaged, is not a violation).

**NOTE:** If inspectors observe air hoses/lines that appear to be resting on or lightly rubbing on vehicle components, but no observable reduction is present, inspectors should educate the driver that this is a condition that, while not in violation, could lead to a violation/out-of-service condition in the future and make comments in the notes only, if so inclined.

**NOTE:** Any chafed air hose or tube that cannot be attributed to the brake system will not be documented as a violation. (e.g. air ride seat).

\*b.(3) When should an air leak in the brake system be documented as a violation?

**ANSWER:** When a vehicle has an air leak at a proper connection or at an undetermined location, and the vehicle passes the CVSA OOSC air loss rate test, inspectors will record a violation for an air leak on the inspection report.

**NOTE:** In 393.45(d), it indicates that the leak has to affect the brake performance under 393.52. Enforcement cannot determine to what extent a leak has to be to affect the brake performance; therefore, any leak in the brake system will be documented as a violation.

**NOTE:** Leaks in the brake system, such as a leak discovered when the treadle valve is applied or a leak in a hose from an air reservoir to a relay valve, will be documented under 393.45(d). Any other leak that cannot be attributed to the brake system or suspension systems (see 393.207(f)) will not be placed out of service and will be documented under 396.3(a)(1).

**\*2. CARGO SECUREMENT**

**OOS Frequently Asked Questions**

a.(1) Shall a tiedown used to secure auxiliary equipment on a heavy vehicle be used in the calculation of the aggregate working load limit?

**ANSWER:** Yes

**Regulatory Guidance**

\*b.(1) Can a bungee cord or tarp strap be used as a primary means of securing an article of cargo and does it need to be rated and marked with a working load limit (WLL)?

**CANADA**

**ANSWER:** Bungee cords and tarp straps are not suitable for use as securement devices and are equally unsuited to having an assigned WLL. There is no intention to prohibit the use of these devices as supplementary restraint for lightweight cargo and equipment.

**EXCEPTION:** Tarp straps can be used as a primary securement for tarps to cover loads.

**UNITED STATES**

**ANSWER:** Bungee cords and tarp straps are not suitable for use as securement devices and are equally unsuited to having an assigned WLL. There is no intention to prohibit the use of these devices as primary or supplemental restraint for articles such as tools and supplies that are not being transported as part of the shipment but are capable of falling from the vehicle if they are not secured. This would include items such as plastic bottles of automotive fluids (e.g. motor oil, windshield washer fluid, water, etc.) used for the operation of the vehicle, tire irons, tools and any other item that may fall from the vehicle.

**EXCEPTION:** Tarp straps can be used as a primary securement for tarps to cover loads.



b.(2) When should a violation be recorded for a damaged tiedown?

**ANSWER:** All tiedowns being used to secure cargo (whether they are required or not) that are damaged to the extent outlined in the CVSA OOSC Cargo Securement Tiedown Defect Table will be recorded as a violation. All other tiedowns with damage not yet to that extent will not be recorded.

b.(3) When transporting “metal coils with eyes crosswise”, other than what is currently outlined in regulation, is there any other means of acceptable securement?

**ANSWER:** Yes, there is a temporary exemption from the regulations if coils are loaded to contact each other in the longitudinal direction, and relative motion between coils, and between coils and the vehicle, is prevented in accordance with the requirements outlined in the Metal Coil Exemption.

b.(4) Other than general provisions, is there a method to secure baled hay and straw that meets the requirements of 49 CFR 393.102(c) as an equivalent means of securement?

**ANSWER:** Yes, providing it meets the requirements outlined in the Technical Review available in the Technical Review of Industry Cargo Securement Practices for Square Bales of Hay and Straw Memo.

b.(5) Is stretch film and/or shrink-wrap an acceptable means of unitizing cargo?

**ANSWER:** Yes, as long as all of the individual articles in the unit of cargo remain secured inside the surface of the material.

b.(6) Is a baled, logged or rolled car considered a “crushed” car for cargo securement specific commodity requirements relative to FMCSR 393.132 and NSC 10, Division 7, Section 90-92.

**ANSWER:** A “crushed car” means a vehicle that has been subjected to mechanical compression that reduces the vehicle’s height as part of a recycling process, without significantly reducing the vehicle’s length or width. A cube of miscellaneous crushed metal must be secured by the general cargo requirements.

b.(7) How must a friction mat be marked to show its coefficient of friction (CoF) value?

**ANSWER:** The CoF, in a numeric value, must be visible. (e.g., 0.5g or 0.8g)

\*b.(8) Does 393.118 (dressed lumber or similar building products) apply to the transportation of building products loaded on pallets or packages of engineered wood products such as beams or trusses?

**ANSWER:** The regulation was not intended to include engineered wood products such as floor joists, beams and trusses. These loads are required to meet the requirements of 393.100 through 393.106 and are not required to be secured as per 393.118.

### 3. COUPLING DEVICES

#### Regulatory Guidance

b.(1) When should movement in the fifth wheel not be documented as a violation?

**ANSWER:** A violation should not be noted until one of the following conditions is met:

- Horizontal movement between the pivot bracket pin and bracket exceeds the CVSA OOSC limit, 3/8 inch (9.5 mm).
- Movement between slider bracket and slider base exceeds the CVSA OOSC limit, 3/8 inch (9.5 mm).
- Horizontal movement between the upper and lower fifth wheel halves exceeds the CVSA OOSC limit, 1/2 inch (12.7 mm).

b.(2) When should a violation of the mounting and integrity of a pintle hook/drawbar not be documented on a semi-trailer?

**ANSWER:** A violation of the coupling device on a semi-trailer should not be documented until the CVSA OOSC is met and in the U.S., the violation should be recorded under 396.3(a)(1). This is necessary because 393.70(c) and (d) only apply to full trailers.

### 4. DRIVELINE/DRIVESHAFT

#### Regulatory Guidance

b.(1) When should movement in the driveline/driveshaft not be documented as a violation?

**ANSWER:** A violation should not be documented until one of the following conditions is met:

- Horizontal or vertical movement of slip joint yoke shaft exceeds the CVSA OOSC limit, 1/2 inch (12.7 mm).
- Independent movement between opposing yoke ends exceeds the CVSA OOSC limit, 1/8 inch (3.2 mm).
- Vertical movement of the shaft in the center bearing carrier exceeds the CVSA OOSC limit, 1/2 inch (12.7 mm).

### \*9. LIGHTING SYSTEMS

#### Regulatory Guidance

b.(1) When shouldn't a violation be documented for inoperative clearance lights on trailers that require them?

**ANSWER:** A violation should not be noted unless the vehicle does NOT have clearance lights on either the upper or lower location. In some instances, trailer manufacturers may be installing the clearance lamps at a location lower than the upper rear corners of the trailer. This is allowed when the practicability of mounting the rear clearance lamps in the header is problematic.

b.(2) What lighting is required on a converter dolly?

**ANSWER:** Despite the wording in Footnote 5 of Section 393.11 of the FMCSRs, after an exhaustive review of rulemaking documents, the following will dictate when a violation should be recorded:

- *Laden converter dolly* – no lights required
- *Converter dolly towed singly by another vehicle and not part of a full trailer* - one stop lamp, one tail lamp, two reflectors, (one on each line of the vertical centerline, as far apart as practicable) on the rear (this assumes that the turn signals of the towing unit are not obscured)
- *Converter dolly towed singly by another vehicle and not part of a full trailer and the converter dolly obscures the turn signals at the rear of the towing vehicle* - one stop lamp, one tail lamp, two reflectors, (one on each line of the vertical centerline, as far apart as practicable) on the rear, and rear turn signals and vehicular hazard warning signal flashing lamps

b.(3) Retro-reflective sheeting is required to be applied to both sides of the trailer at a height of at least 15 inches (380 mm) and not more than 60 inches (1,525 mm) above the road surface. In some cases, when this height is complied with on tank trailers, the sheeting will be canted downward. Therefore, in some cases, the sheeting is applied higher than what is outlined in the regulations but is located as close as practicable to the required height and still allows for the tape to be mounted on a horizontal plane or as close to it as the shape of the trailer allows. In these cases, should a violation be documented?

**ANSWER:** No, if a cargo tank does not have a frame or other suitable surface below the 60 inches (1,525 mm) height to apply the sheeting in order for it to be on a horizontal plane, the sheeting may be located at a higher location, as close to the required height as practicable, and no violation should be documented.

**\*10. STEERING MECHANISMS**

**Regulatory Guidance**

b.(1) When should vertical or horizontal movement in a ball and socket joint not be documented as a violation?

**ANSWER:** A violation should not be noted until motion, other than rotational, between any linkage member and its attachment point exceeds the limit prescribed in the CVSA OOSC, 1/8 inch (3.2mm), measured with hand pressure only.

**NOTE:** The Federal Motor Carrier Safety Administration (FMCSA) is aware of the discrepancy between the measurement in Appendix G and the CVSA OOSC. Using the CVSA OOSC as a guideline allows for some play in the ball and socket joint, but more importantly, provides inspectors with an objective measurement criterion that will ensure uniformity when writing the violation.

**\*11. SUSPENSIONS**

**OOS Frequently Asked Questions**

a.(1) In a Peterbilt air suspension assembly, is a loose or missing spring eye u-bolt an out-of-service condition?

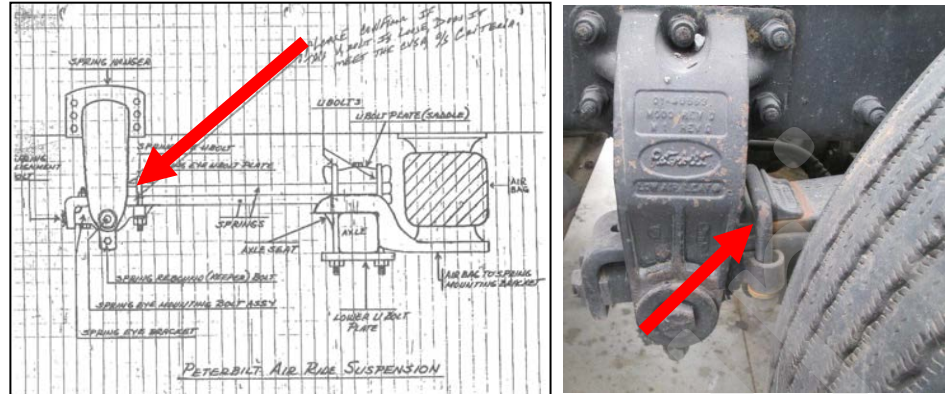

**ANSWER:** No, not unless it has somehow resulted in axle displacement.

a.(2) Is a loose or missing rebound bolt a violation or out of service?



**ANSWER:** A rebound bolt in a spring hanger or equalizer that is loose is not considered a violation. A missing or broken rebound bolt is considered a violation but not out of service.

a.(3) If the cross tube brace is cracked, loose, corroded or broken, is it a violation or an out-of-service condition?

**ANSWER:** These conditions are not a violation or out-of-service. The cross tube brace is used to position the suspension for shipment and installation and has no bearing on the alignment or the function of the suspension.

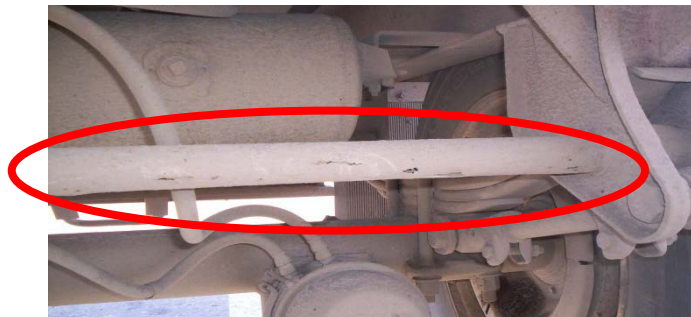

a.(4) What is the difference between a primary and aftermarket/secondary air bag suspension?

**ANSWER:** The primary air bag suspension system is maintained in accordance with original manufacturer specifications, whereas a secondary air bag suspension system is in addition to the original manufacturer spring or coil suspension.



Original Manufacturer  
Equipment  
(Leaf/Air Primary Suspension)



Aftermarket/Secondary Air Suspension  
(Air Bag Supplements the Primary Leaf  
Spring Assembly)

**NOTE:** Deflated aftermarket/secondary air bag suspension in addition to a primary leaf/coil spring suspension does not result in a violation.

**\*12. TIRES**

**OOS Guidance**

a.(1) What is a major tread groove on a tire for the purposes of measuring tread depth?

**ANSWER:** A major tread groove is the space between two adjacent tread ribs or lugs on a tire that contains a tread wear indicator or wear bar. In most cases, the locations of tread wear indicators are designated on the upper sidewall/shoulder of the tire on original tread tires.

**Regulatory Guidance**

b.(1) If a tire has a max inflation pressure of 110 psi but measures 80 psi, should a violation be written? If so, what section?

**ANSWER:** No, a violation should not be written. To issue a violation for having low inflation pressure, the inspector would have to have a chart that identifies the load-carrying capacity for the tire at different inflation pressures as well as for the particular load that is being carried. There are too many different tire sizes to put this level of information into the regulation.

An underinflated tire is not a violation until it meets the OOSC; 393.75(a)(3) is the proper section to be used. 393.75(i) should not be written for an underinflated tire. A violation of 393.75(g) should only be written when the opportunity to weigh a vehicle is present and the weight on a tire exceeds the tire load-carrying capacity (as printed on the sidewall of the tire).

**\*14. WHEELS, RIMS AND HUBS**

**OOS Frequently Asked Questions**

- a.(1) Is it an out-of-service condition when a vehicle has had a tire or rim problem and a driver or owner has either singled out the axle or has removed the wheels and chained up the axle?

If the vehicle arrives at an inspection site in this condition, this is not a violation unto itself, but other violations may have resulted from this action (e.g., exceeds tire weight rating).

However, if a vehicle is inspected, the driver should not be permitted to single out a tire or chain up an axle as a quick fix for an out-of-service defect. This does not comply with CVSA Operational Policy 5 which states:

**“...REQUIRED REPAIRS FOR OUT-OF-SERVICE NOTICES**

The following shall be the policy regarding required repairs for out-of-service notices:

No motor carrier shall require nor shall any person operate or any inspector release any commercial motor vehicle declared out of service until all repairs required by the out-of-service notice have been satisfactorily completed to where the violations(s) no longer exists. ...”

**\*XX. MISCELLANEOUS**

**Regulatory Guidance**

**\*WINDSHIELDS**

- b. (1) When should a violation be noted for external visors that have been added to a vehicle that obstruct the view of the driver?

**ANSWER:** 393.60(e)(1) of the FMCSRs only applies to items that are mounted on the windshield, not in front of the windshield. There is no current guidance as to how much of the windshield can be covered by external visors, so in extreme cases where a significant portion of the windshield is obscured by external visors mounted in front of the windshield, a violation can be documented under 396.3(a)(1) or 393.3.

**\*REAR IMPACT GUARDS**

- b. (2) Should a violation be cited under 393.86(a)(6) for a missing or incomplete certification label on a rear impact guard?

**ANSWER:** The certification label is applied at time of trailer manufacture to certify that the guard was manufactured to comply with FMVSS 223 and installed as required by FMVSS 224 and should not be considered a violation once the vehicle is in use.

Violations are not to be cited for certification and labeling requirements for rear impact guards referenced in 393.86(a)(6). The condition of rear impact guards should be inspected to ensure compliance with all other FMVSS 223 requirements such as:

- Connection points (393.86(a)(1))
- Guard width (393.86(a)(2))
- Guard height (393.86(a)(3))
- Guard rear surface (393.86(a)(4))
- Cross section of the horizontal member (393.86(a)(5))

Any violations of the above conditions should be cited under the appropriate violation code during a Level I, II or V inspection.

**\*OIL AND GREASE LEAKS**

b. (3) At what point should an oil and/or grease leak be written as a violation of 396.5?

**ANSWER:** A violation should not be written until the seepage or leak is great enough to form drops and drip during an inspection.

Missouri